

## MAINTENANCE:

Use a soft, lint - free cloth to clean the metal frame.

**UNDER NO CIRCUMSTANCES  
SHOULD METAL POLISHES, CLEANERS,  
ABRASIVES OR AEROSOL SPRAYS  
BE USED.**

While the latest finishing techniques have been used on the metal frame, such finish cannot be unconditionally guaranteed. The main cause of deterioration, apart from certain atmospheric conditions, is improper cleaning.

To clean the crystals, polish with a damp chamois.

You are cleaning delicate jewelry... Take the greatest care.

## IMPORTANT:

Do not clean crystals in a dishwasher. The finish of the metal clips and hangers will be ruined and the crystals may be damaged.

# SCHONBEK®

# CHANDELIER 3572- \_\_\_\_\_ - \_\_\_\_\_ TRIM DIAGRAM

(Finish Option)

(Trim Option)

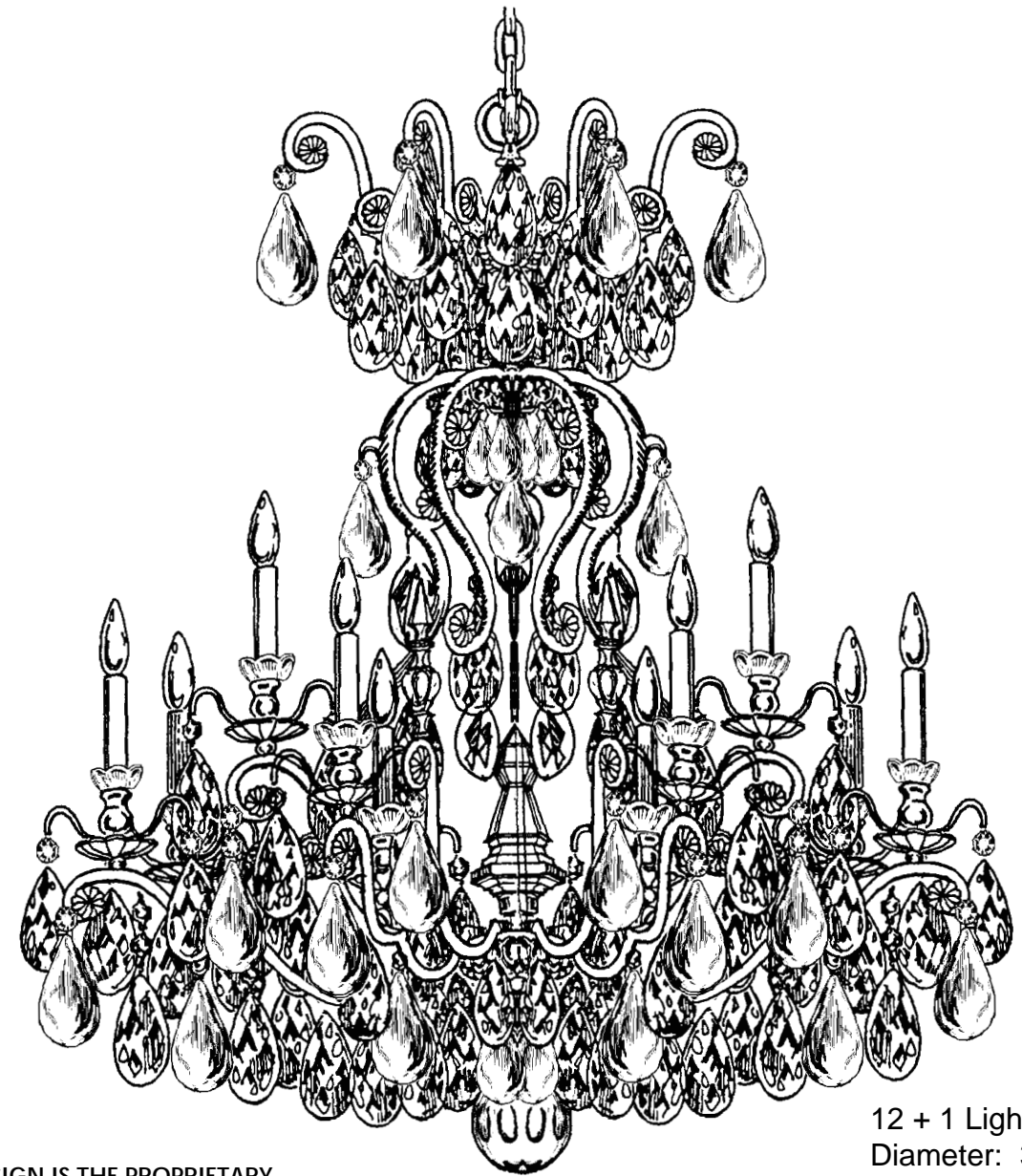

**T**HIS DESIGN IS THE PROPRIETARY  
TRADE DRESS/TRADEMARK OF  
SCHONBEK WORLDWIDE LIGHTING INC.

12 + 1 Lights  
Diameter: 32"  
Body Length: 40"  
Hanging Weight: 60 lbs.

# SCHONBEK®

**Follow steps in exact order  
Save this trim diagram for future reference**

**1**

### IMPORTANT

*Person who opens carton should record the following information for future service.*

CODE # \_\_\_\_\_ Four-digit number on outside of carton.  
PACKER # \_\_\_\_\_ See crystal package label.  
ORDER # \_\_\_\_\_ See crystal package label.

SCHONBEK IS A WORLD LEADER IN CHANDELIER DESIGN. PATENTS INCLUDE:  
#D5,222,805,#D335,362,#D336,537 & #D374,102

## Instructions for electrician STEPS 2 - 20

2

WARNING:

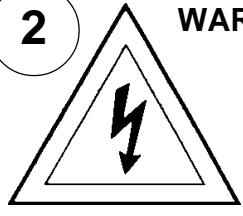

Electrical Danger

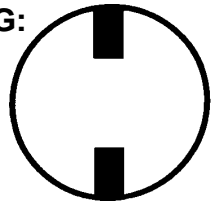

Turn Power Off

All electrical components must be installed by a licensed electrician in accordance with the National Electric Code and the appropriate local electrical codes.

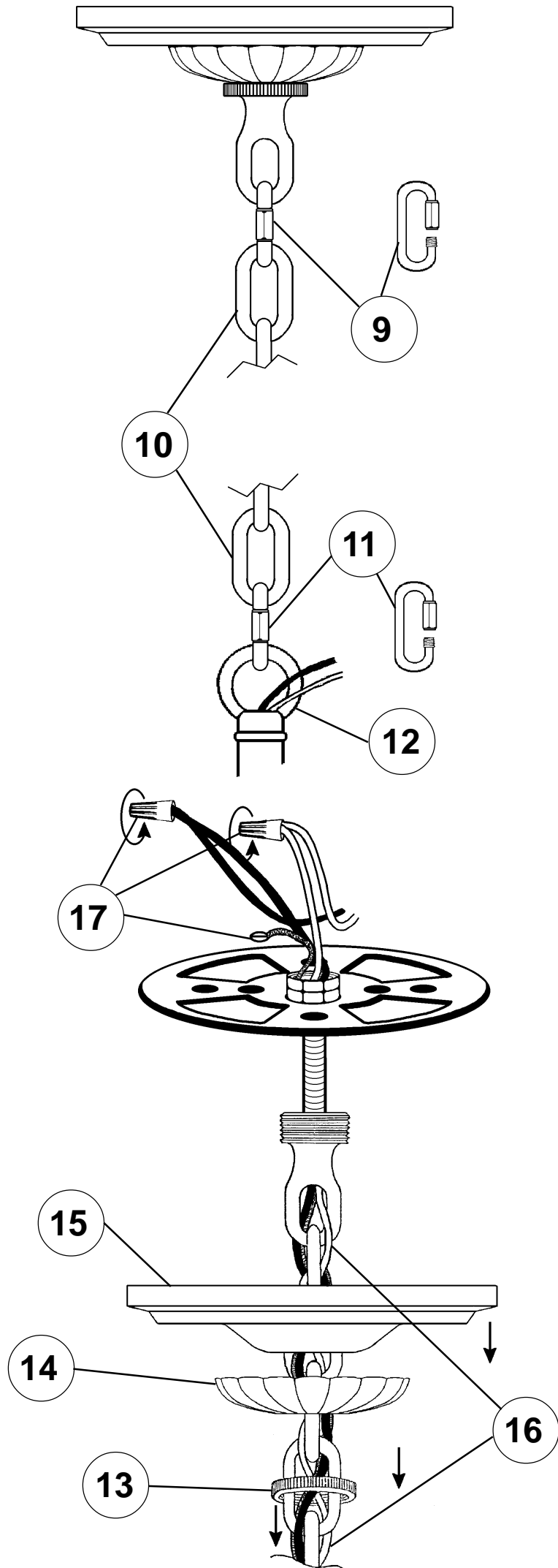
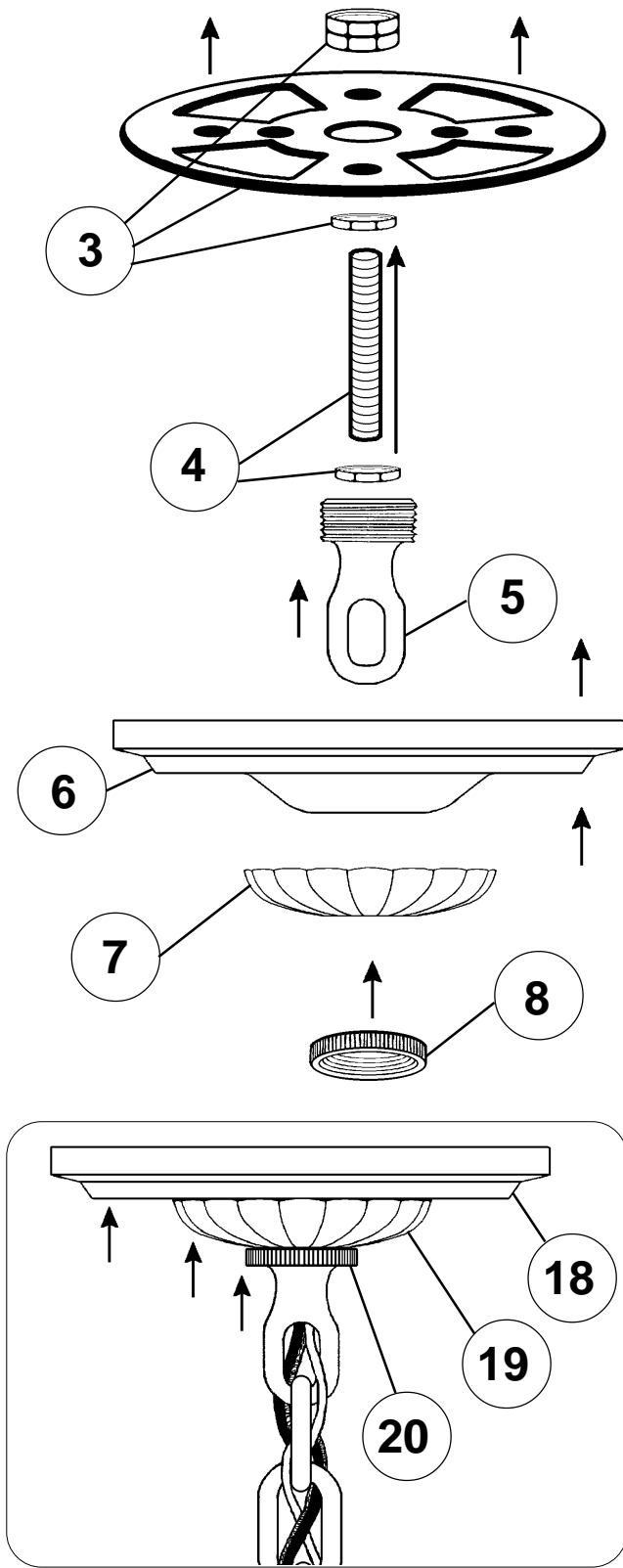

## SET #1

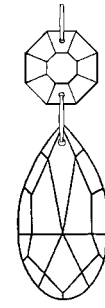

**F**  
(N10267\*\*)  
2"  
50mm

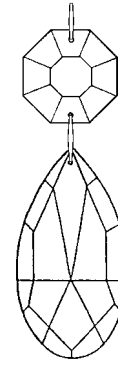

**G**  
(N10196)  
2-1/2"  
63mm



**H**  
(N10262)  
3"  
76mm

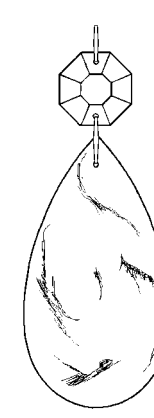

**J**  
(N 10311)  
3"  
76mm

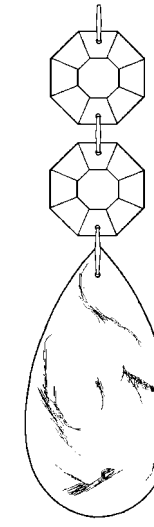

**K**  
(N10312)  
3"  
76mm

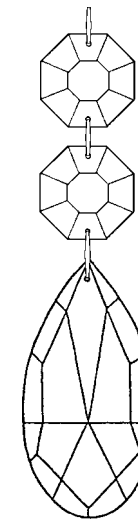

**L**  
(N10313\*\*)  
3"  
76mm

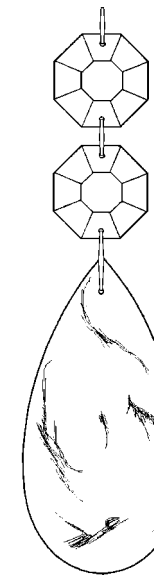

**M**  
(N10314)  
3-1/2"  
89mm

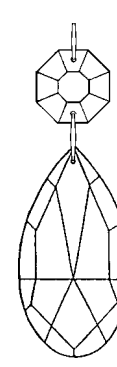

**N**  
(N10223\*\*)  
2-1/2"  
63mm

## SET #2

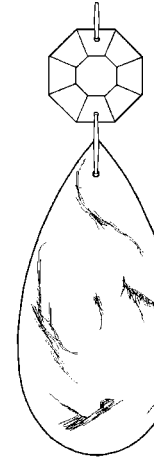

**D**  
(N10276)  
3-1/2"  
89mm

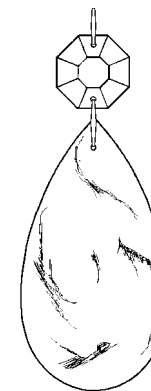

**J**  
(N10311)  
3"  
76mm

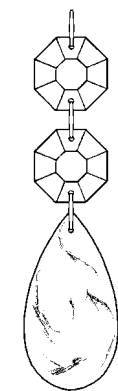

**O**  
(N10315)  
2"  
50mm

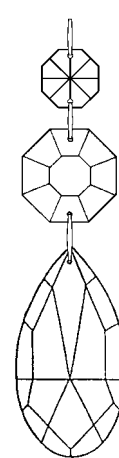

**P**  
(N10268\*\*)  
2-1/2"  
63mm

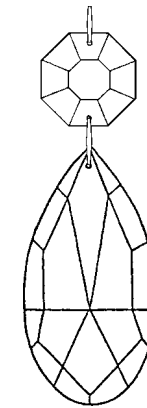

**Q**  
(N10191)  
3"  
76mm

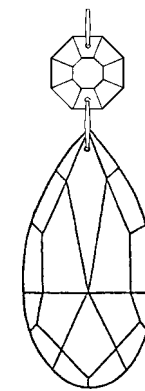

**R**  
(N10273\*\*)  
3"  
76mm

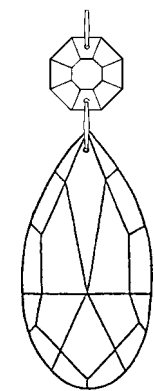

**T**  
(N10273)  
3"  
76mm

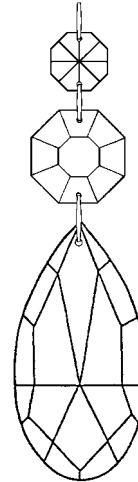

**U**  
(N10202\*\*)  
3"  
76mm

## SET #3

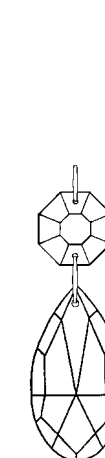

**A**  
(N10267)  
2"  
50mm

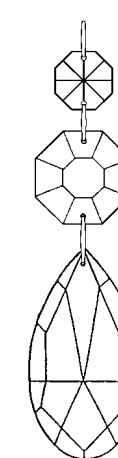

**B**  
(N10268\*\*)  
2-1/2"  
63mm

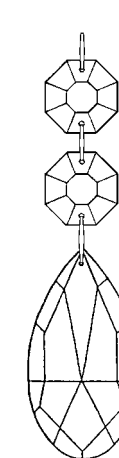

**C**  
(N10275)  
2-1/2"  
63mm

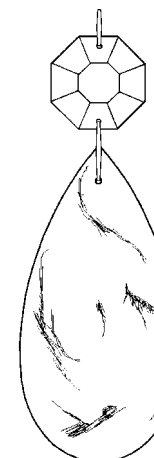

**D**  
(N10276)  
3-1/2"  
89mm

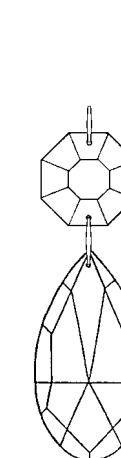

**G**  
(N10196)  
2-1/2"  
63mm

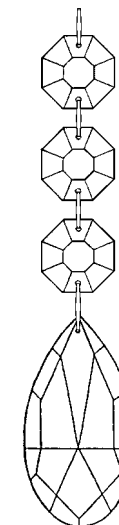

**V**  
(N10266\*\*)  
2-1/2"  
63mm

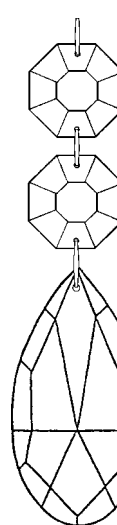

**W**  
(N10313\*\*)  
3"  
76mm

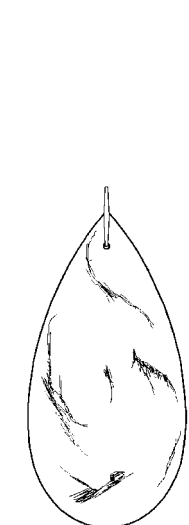

**X**  
(N10193)  
3-1/2"  
89mm

**Crystal Set #3 in Black**

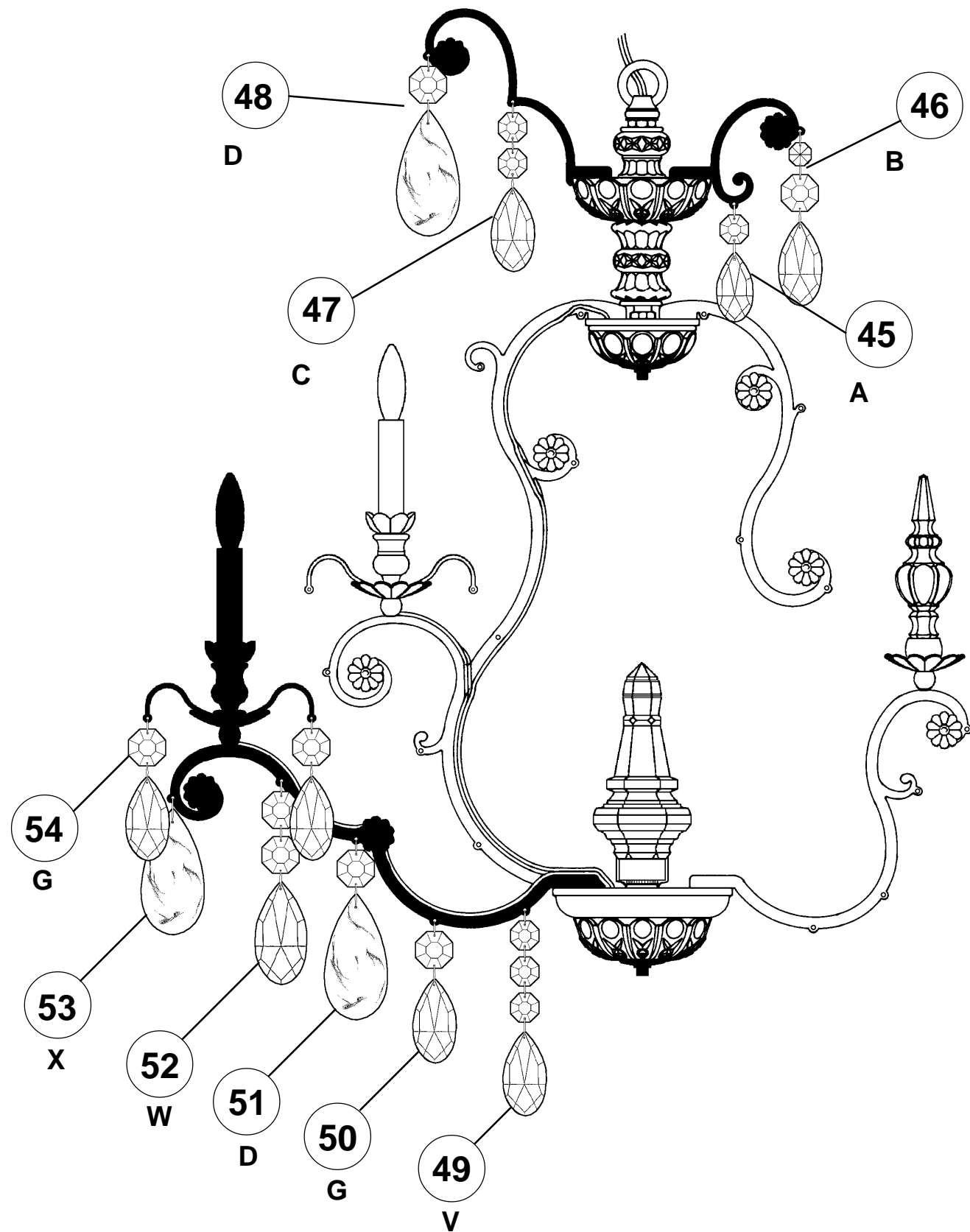

For easy removal of crystal from bubble pack, please cut along pouches on the inside of the seam. Gently remove crystal from the side of the pouch.

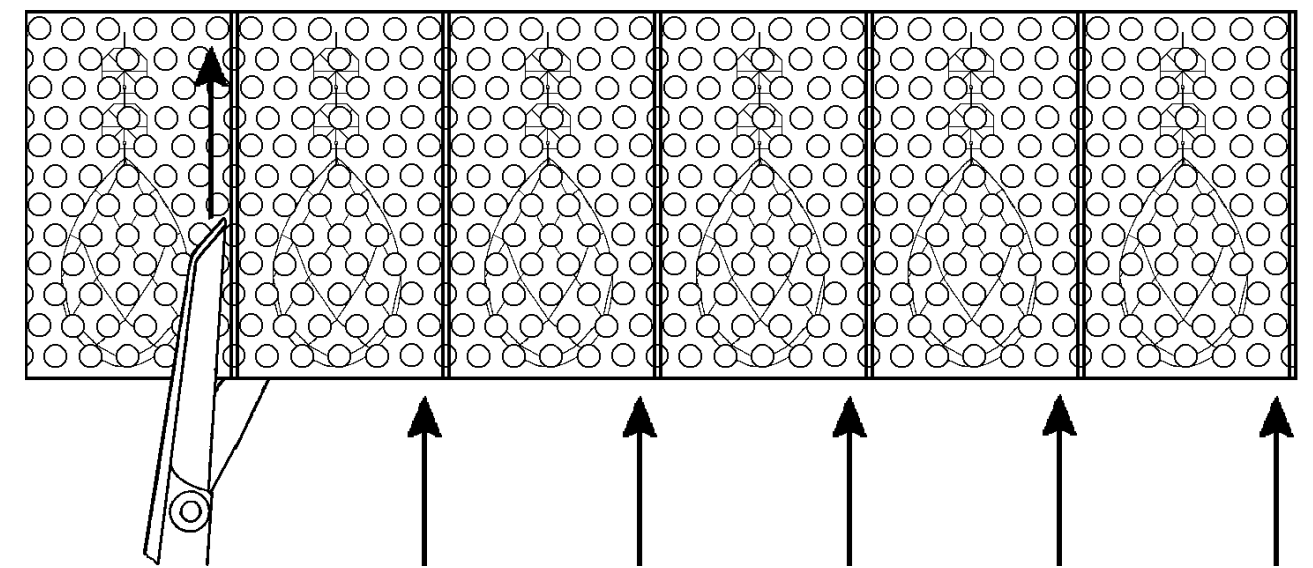

**NOTE: Work on one crystal set at a time. Follow the black line from top to bottom according to the numbered steps on the trim diagram.**

# Instructions for crystal trimming STEPS 21 - 54

**FIXTURE INCLUDES:**  
Hanger Hardware  
Trim - Frame  
1 - T7 Light Bulb

**DOES NOT INCLUDE:**  
C10 - Light Bulbs

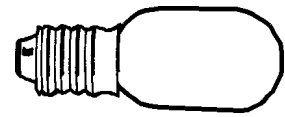

You will need 1 - T7  
15 Watts Max  
(Center Light)

22

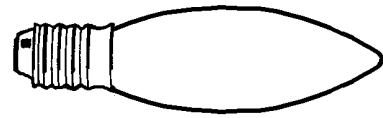

You will need 12 - C10  
25 Watts Recommended  
60 Watts Max

Install bulbs and be  
sure to test fixture  
**BEFORE** trimming.

## Crystal Set #1 in Black

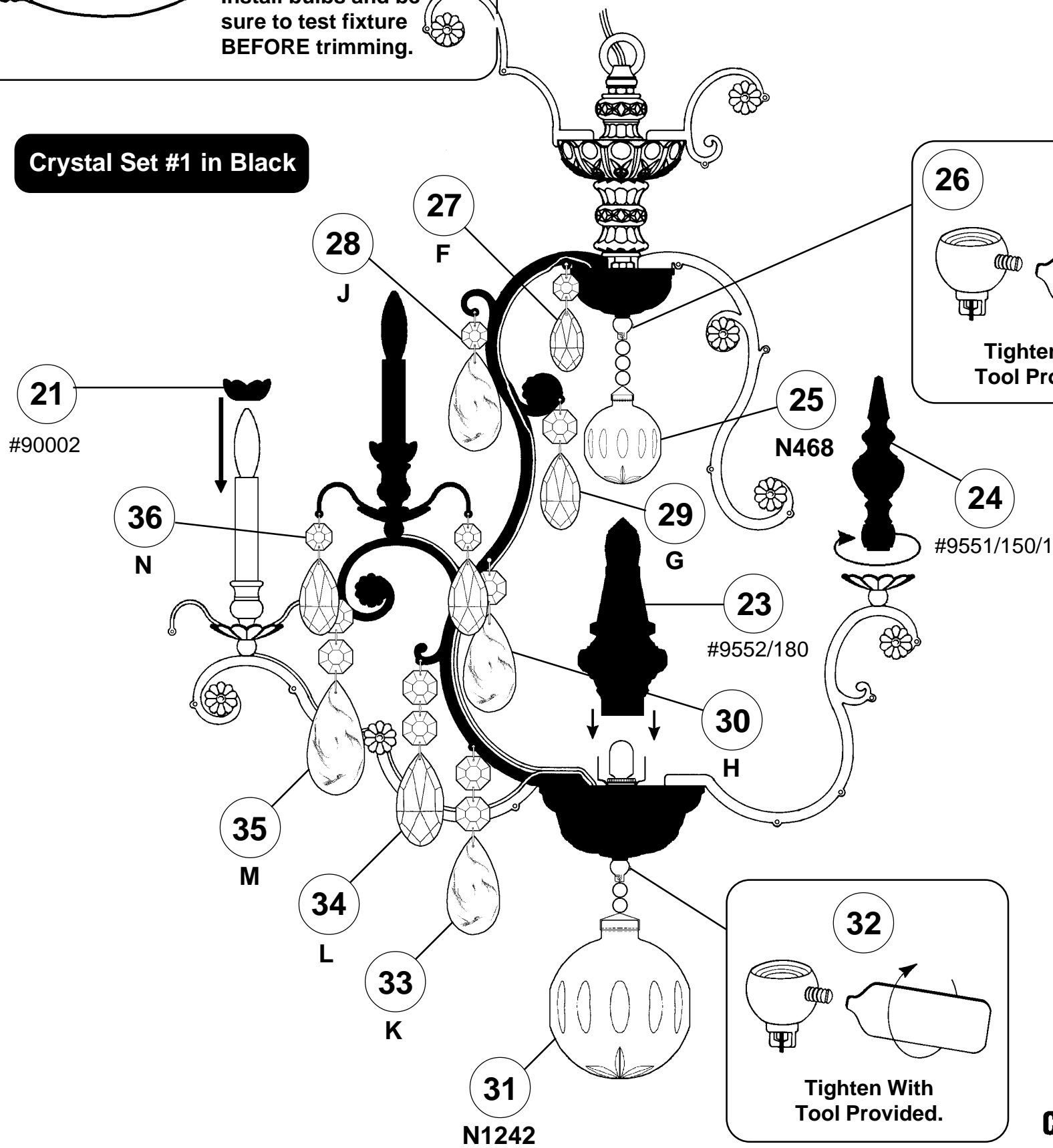

## Crystal Set #2 in Black

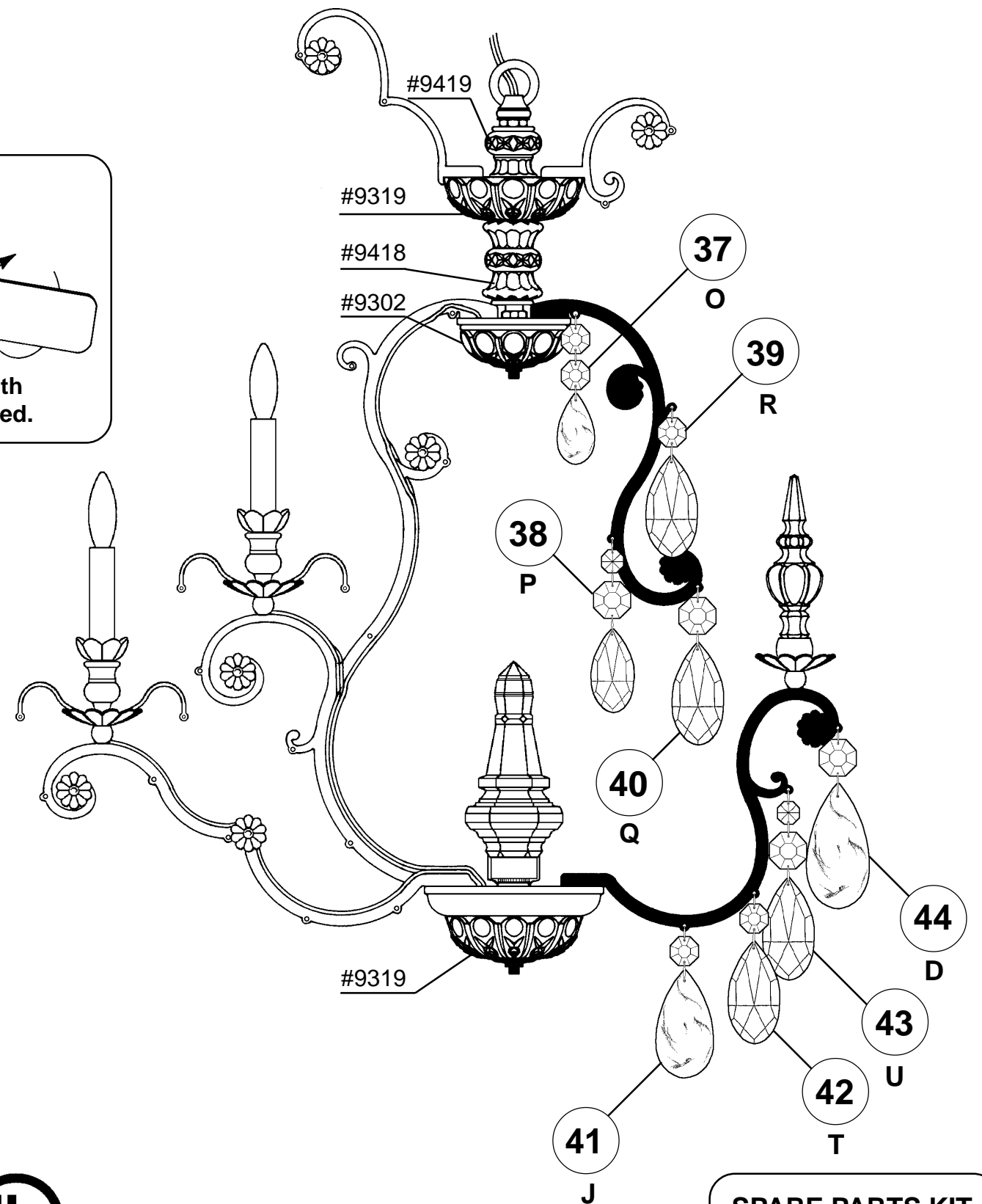

**SPARE PARTS KIT  
PROVIDED.**

