

SARELLA RS8333N- __ __ H

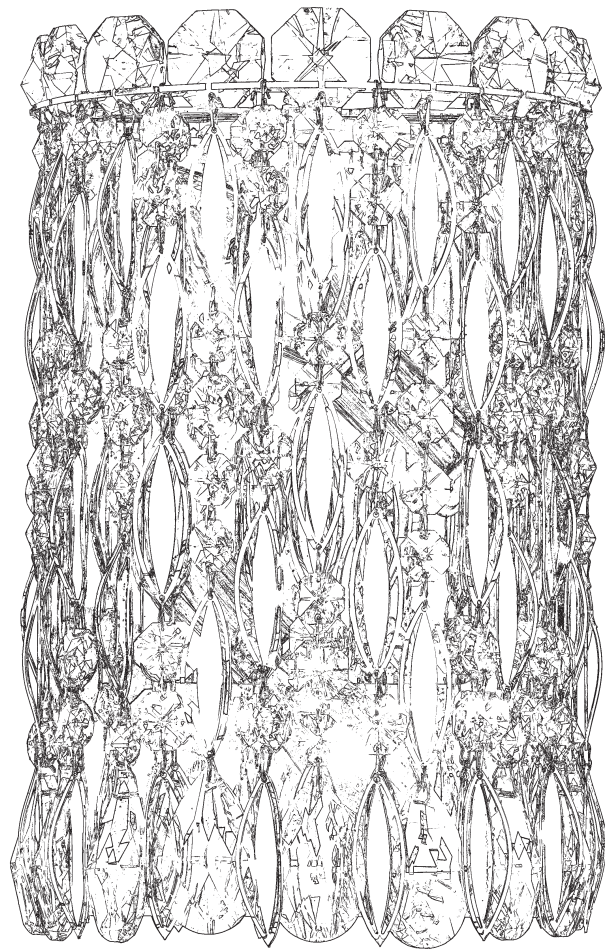









2 Lights
Length: 7"
Height: 11"
Extension: 4-1/2"
Hanging Weight: 4lbs.

THIS DESIGN IS THE PROPRIETARY
TRADE DRESS/TRADEMARK OF
W SCHONBEK LLC.

 **SCHONBEK** | 1870

 **SCHONBEK** | 1870

| | | | | | | | | |
|---------------------------------------------------------------------------------------|---------------------------------------------------------------------------------------|---------------------------------------------------------------------------------------|---------------------------------------------------------------------------------------|---------------------------------------------------------------------------------------|---------------------------------------------------------------------------------------|---------------------------------------------------------------------------------------|---------------------------------------------------------------------------------------|---------------------------------------------------------------------------------------|
|  |  |  | S |  |  |  |  |  |
| MAX <u>40</u> W | | 110-120 V |  | | | | | |

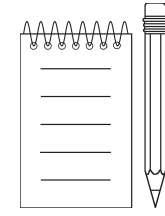
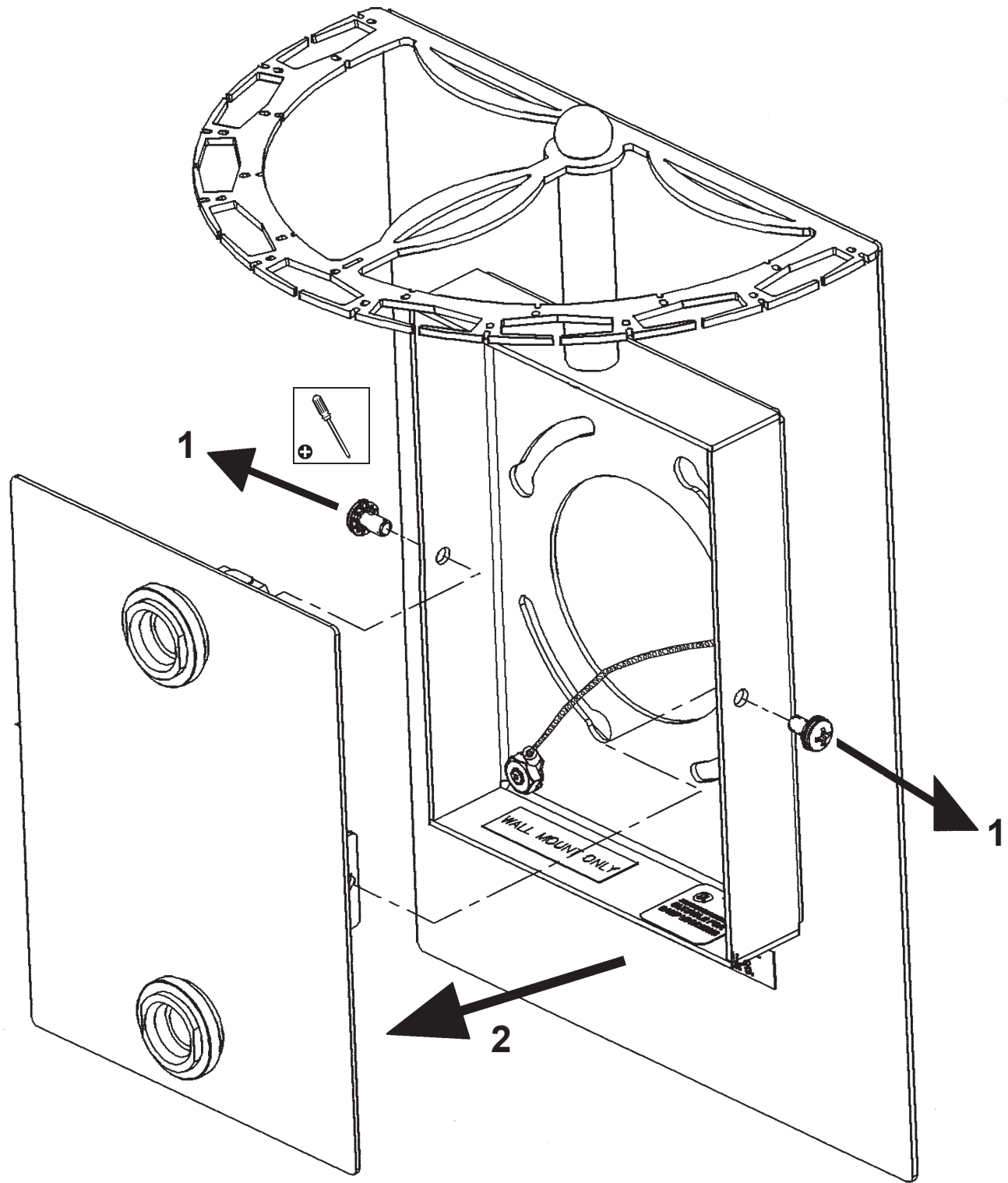

12

TRIM PLATE - TOP VIEW

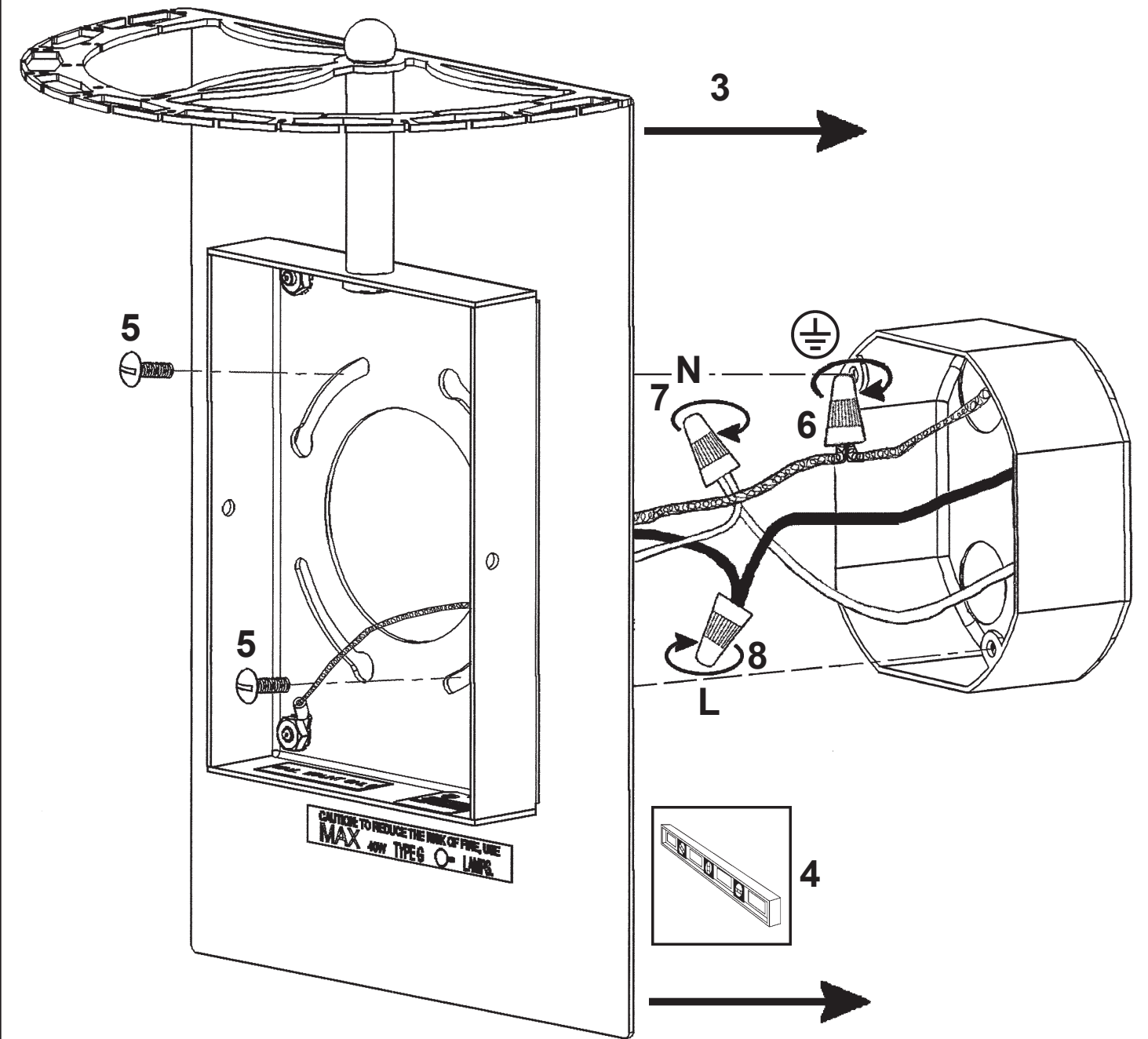
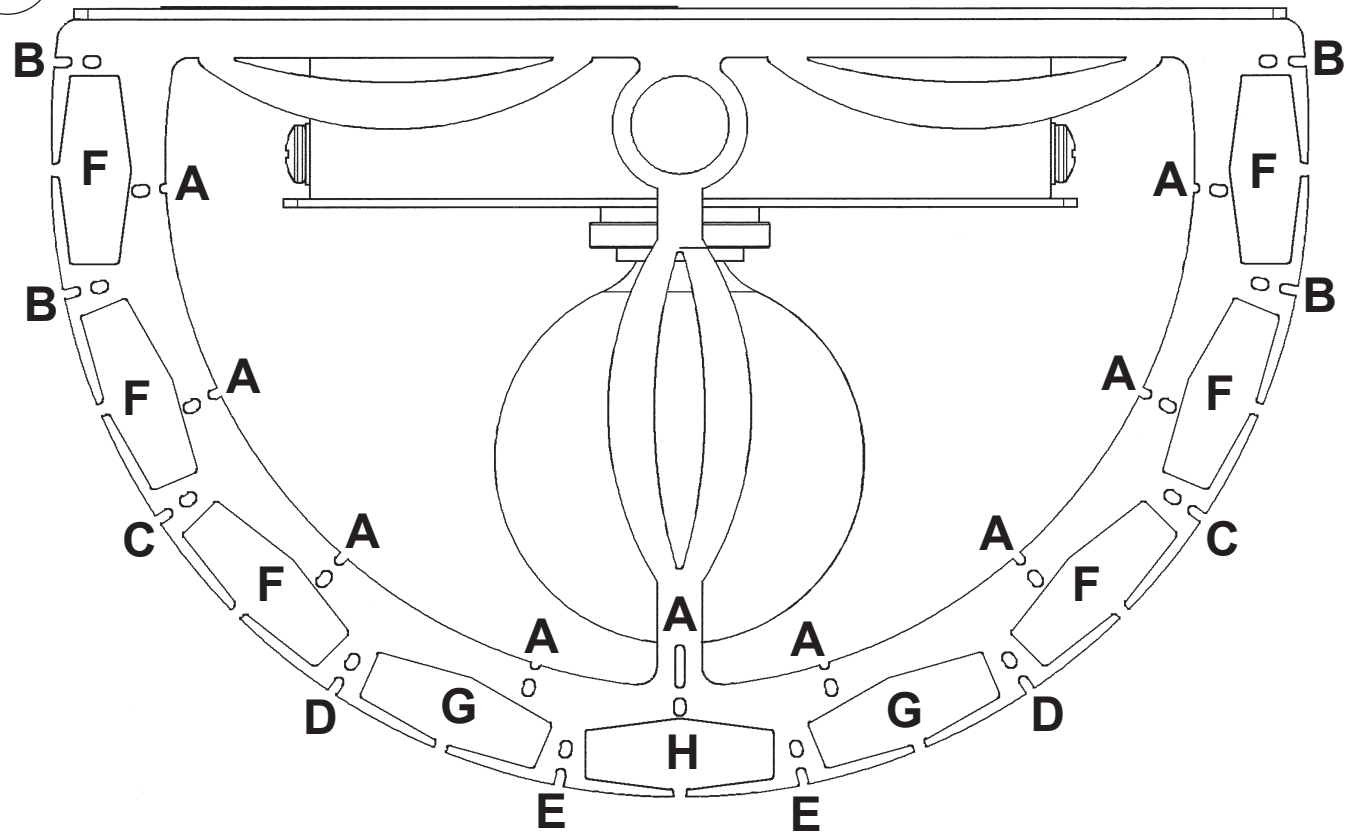

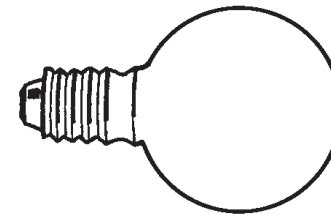

You will need 2 - G16-1/2
25 Watts Recommended
40 Watts Max

Install bulbs and be sure
to test fixture **BEFORE**
trimming.

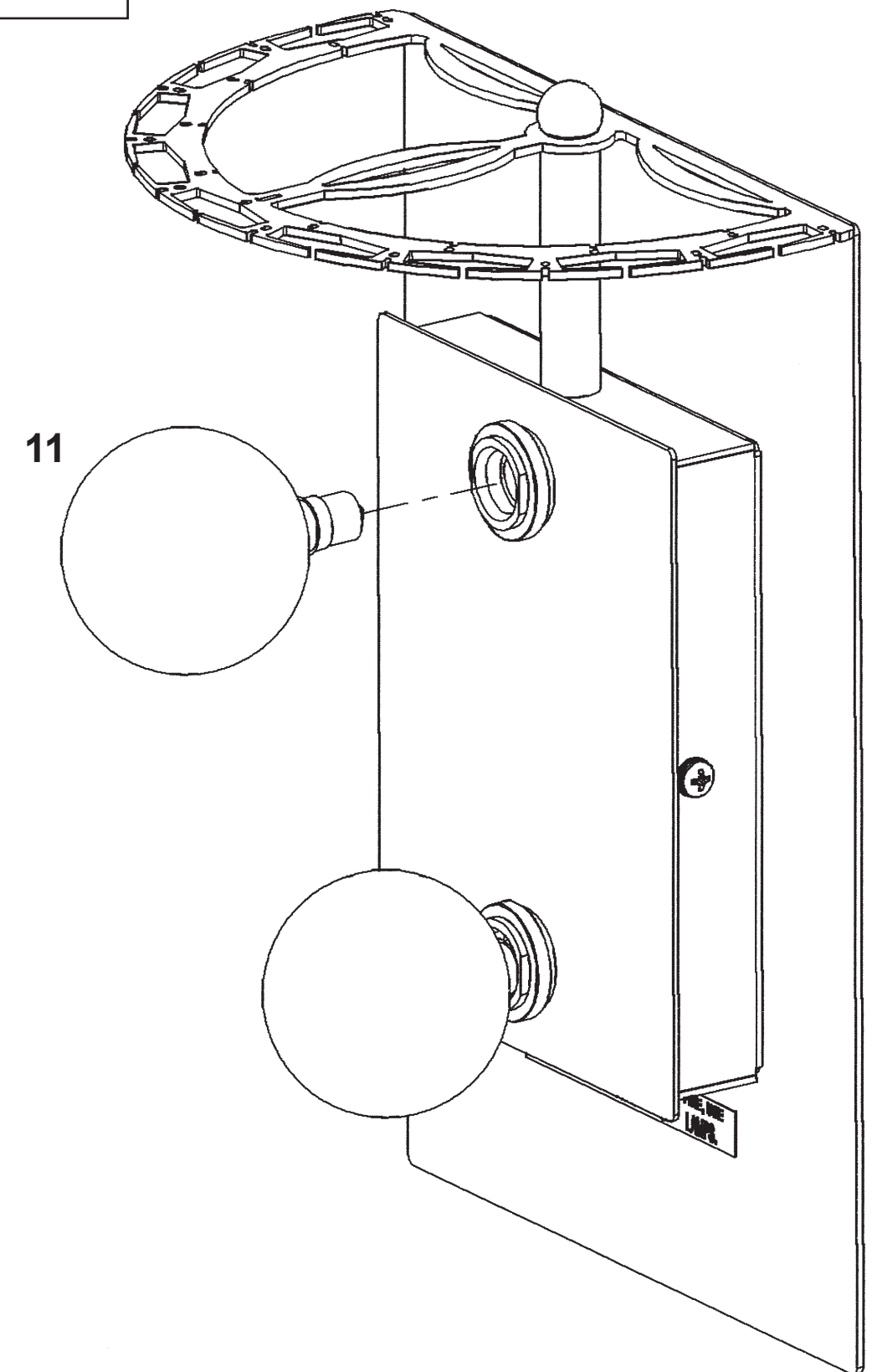
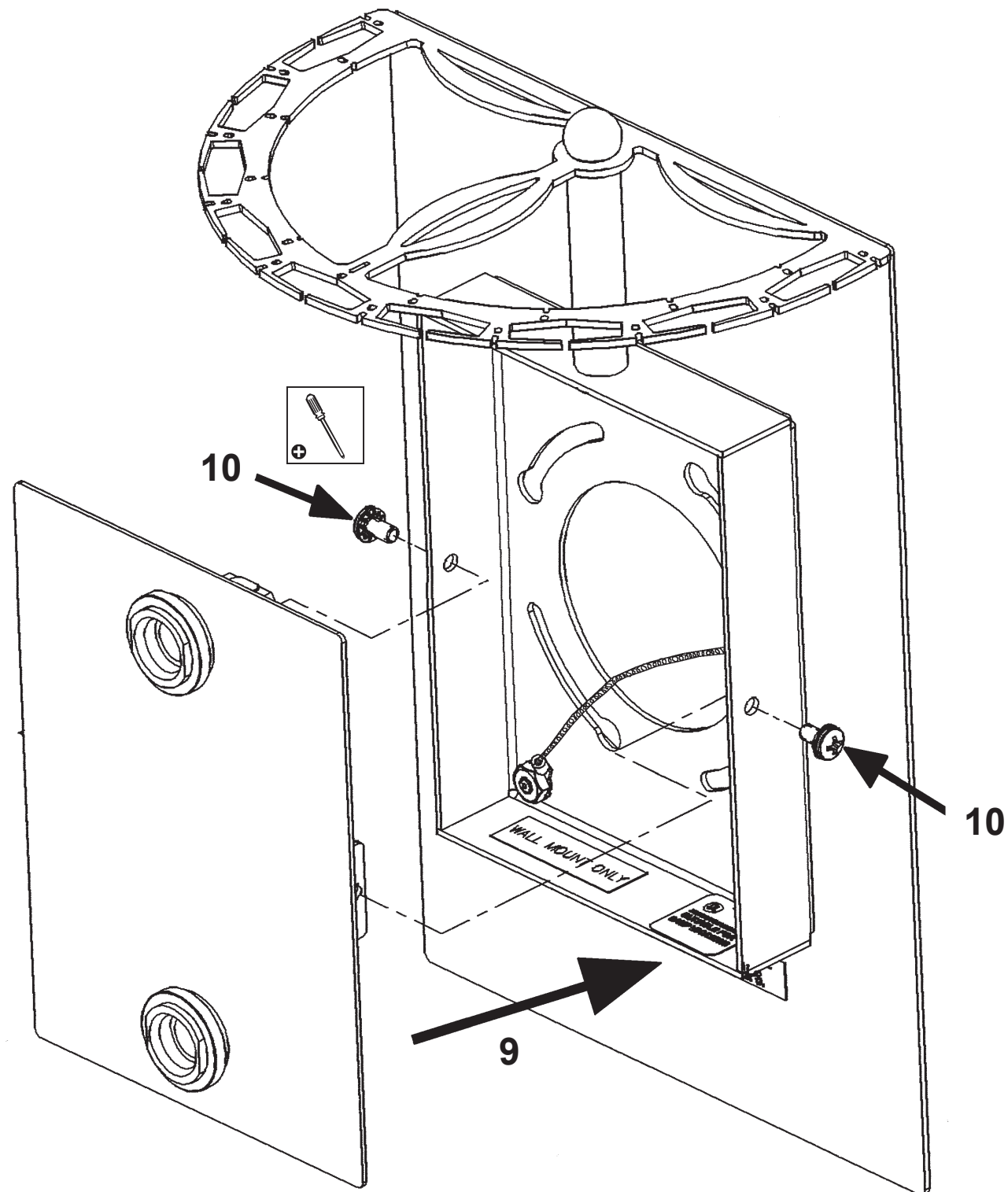

SARELLA RS8333N-__ __R

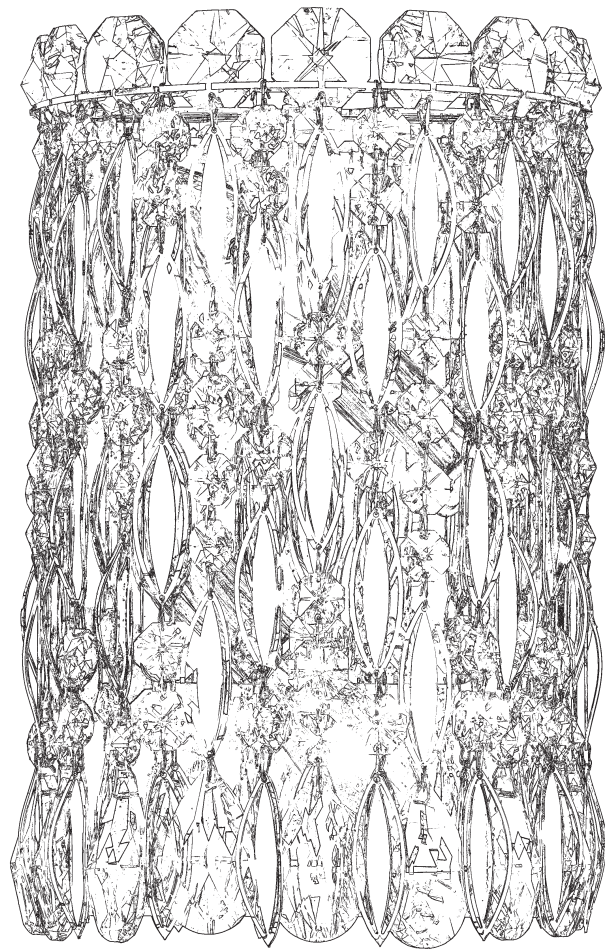











2 Lights
Length: 7"
Height: 11"
Extension: 4-1/2"
Hanging Weight: 4lbs.

THIS DESIGN IS THE PROPRIETARY
TRADE DRESS/TRADEMARK OF
W SCHONBEK LLC.

 **SCHONBEK** | 1870

 **SCHONBEK** | 1870

| | | | | | | | | |
|---------------------------------------------------------------------------------------|---------------------------------------------------------------------------------------|---------------------------------------------------------------------------------------|---------------------------------------------------------------------------------------|---------------------------------------------------------------------------------------|---------------------------------------------------------------------------------------|---------------------------------------------------------------------------------------|---------------------------------------------------------------------------------------|---------------------------------------------------------------------------------------|
|  |  |  |  |  |  |  |  |  |
| MAX <u>40</u> W | | 110-120 V |  | | | | | |

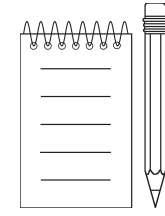
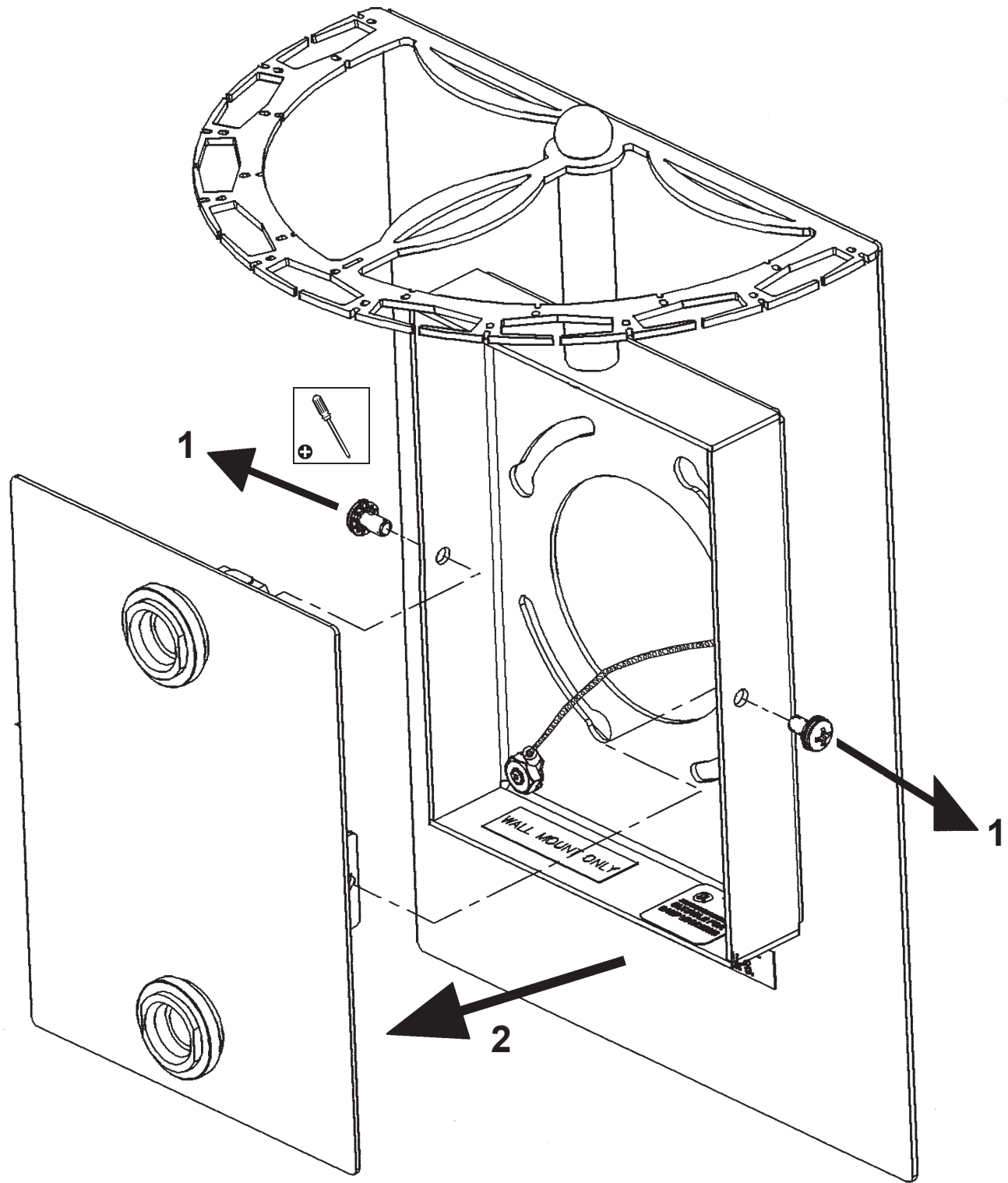

12

TRIM PLATE - TOP VIEW

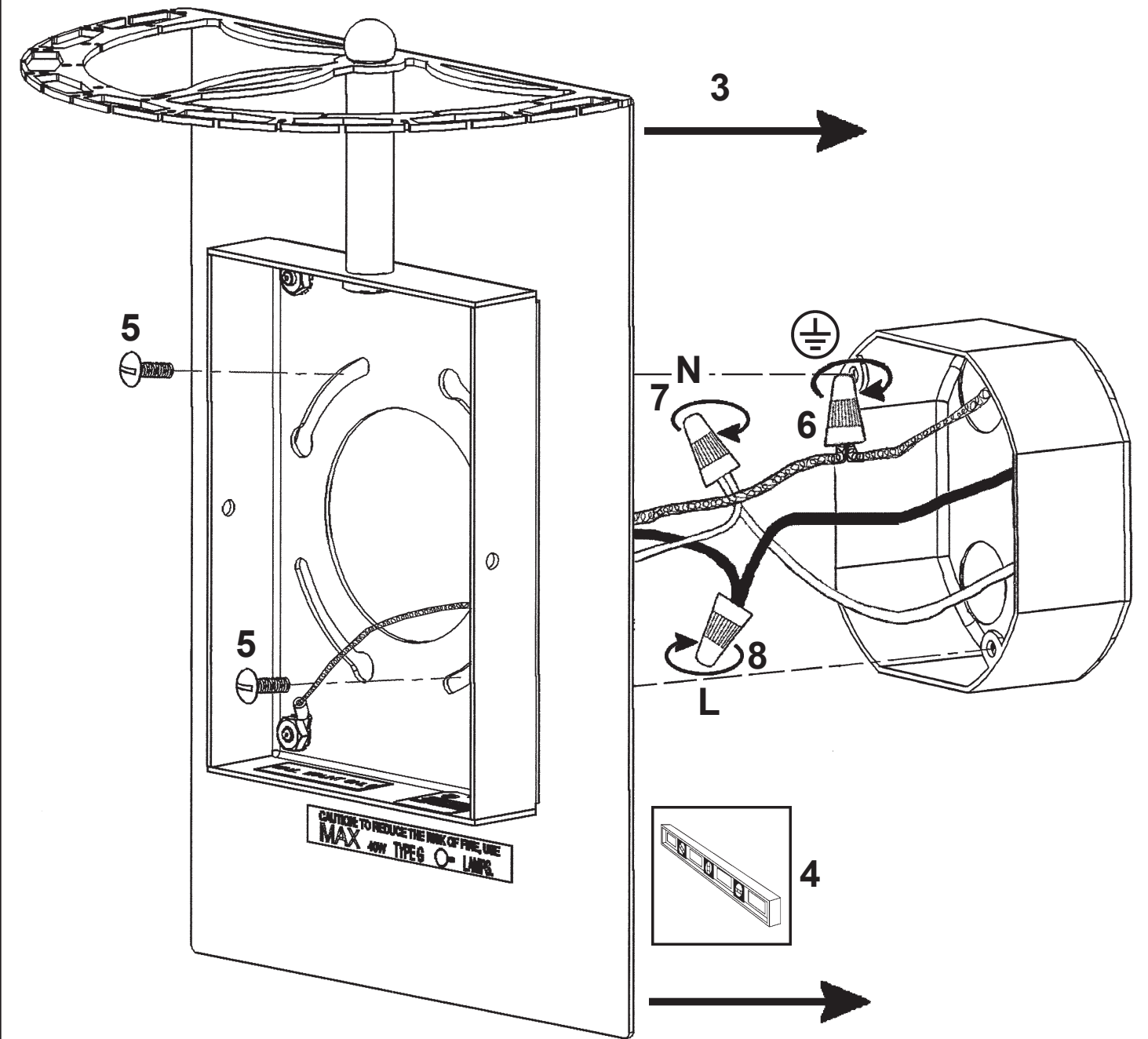
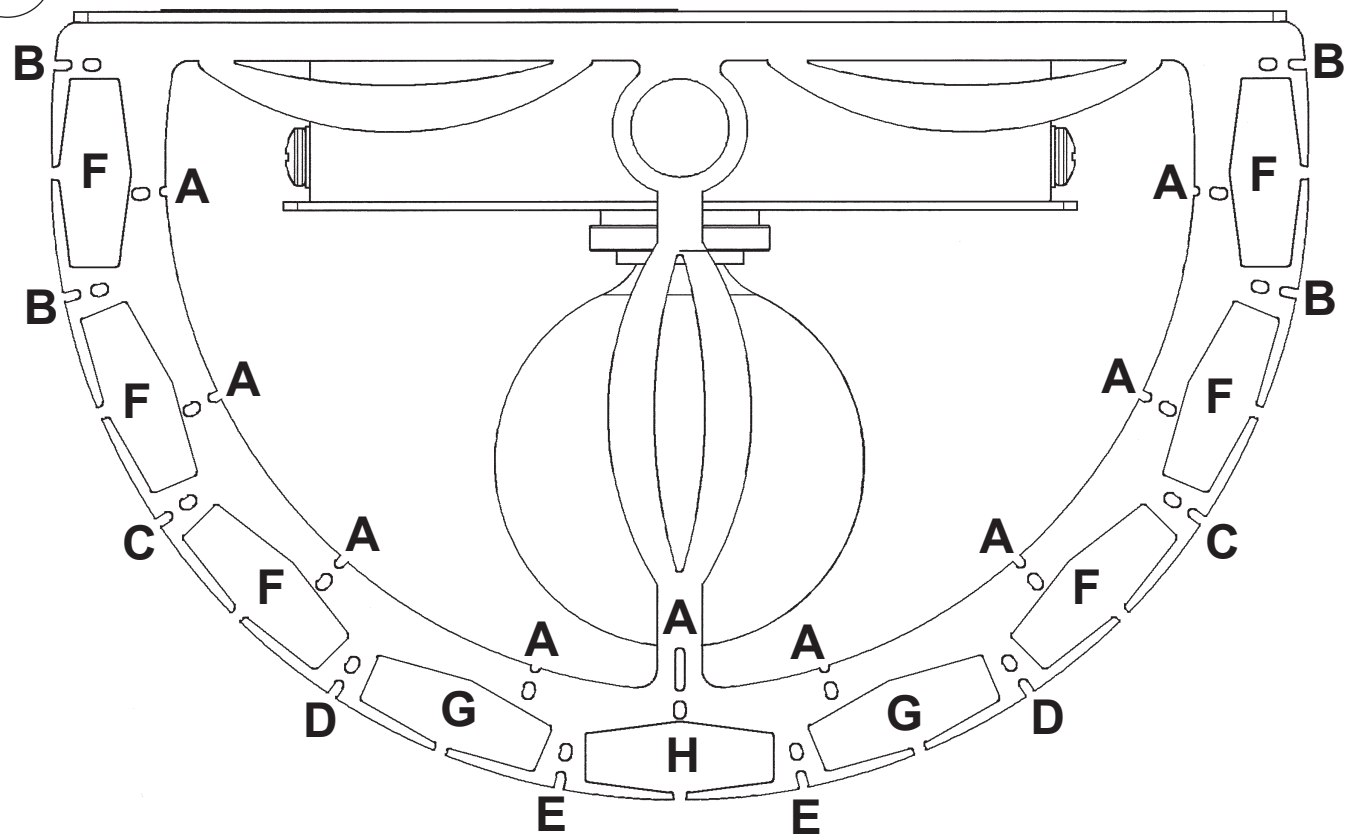

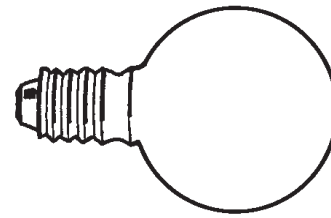

You will need 2 - G16-1/2
25 Watts Recommended
40 Watts Max

Install bulbs and be sure
to test fixture **BEFORE**
trimming.

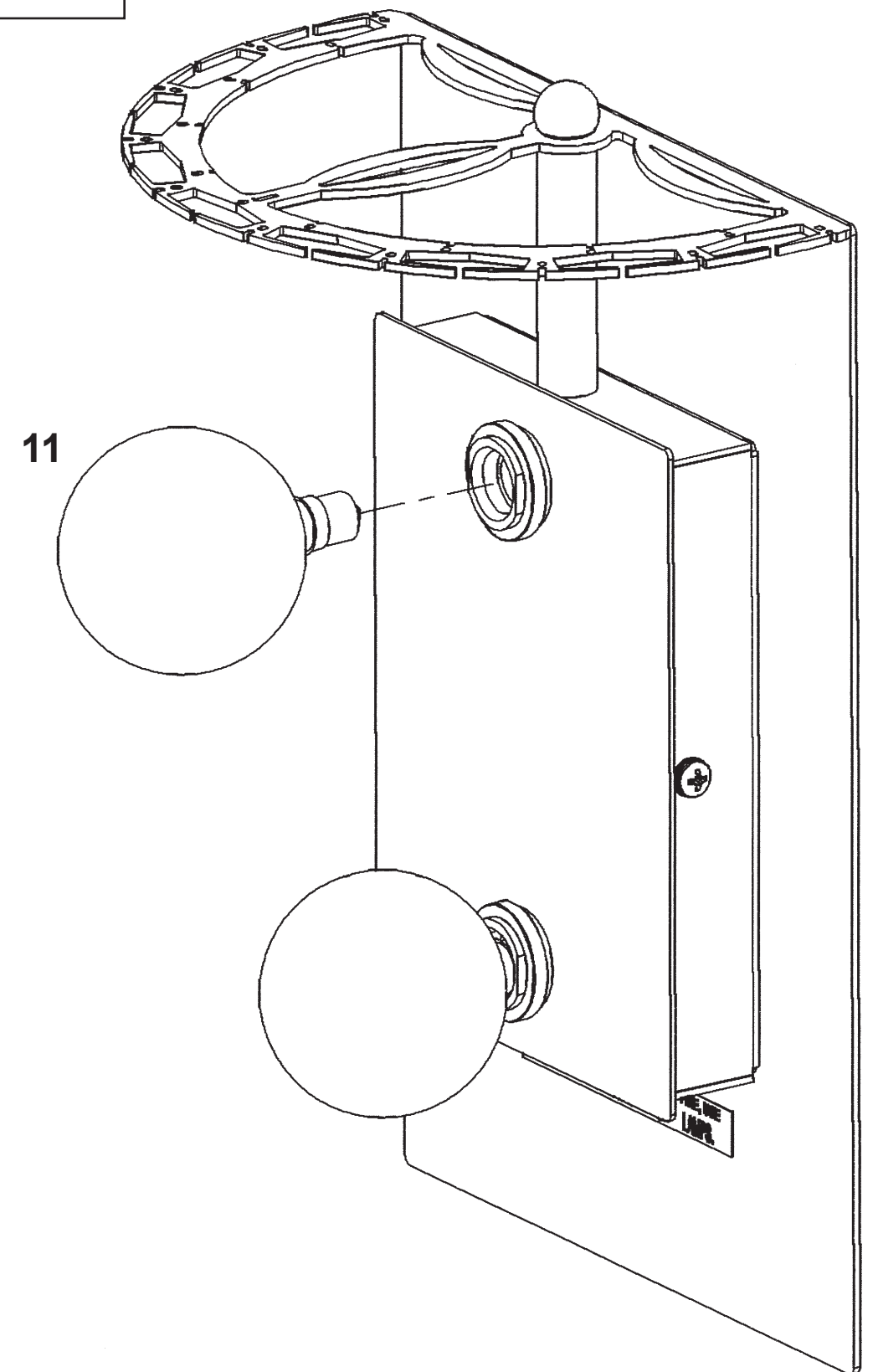
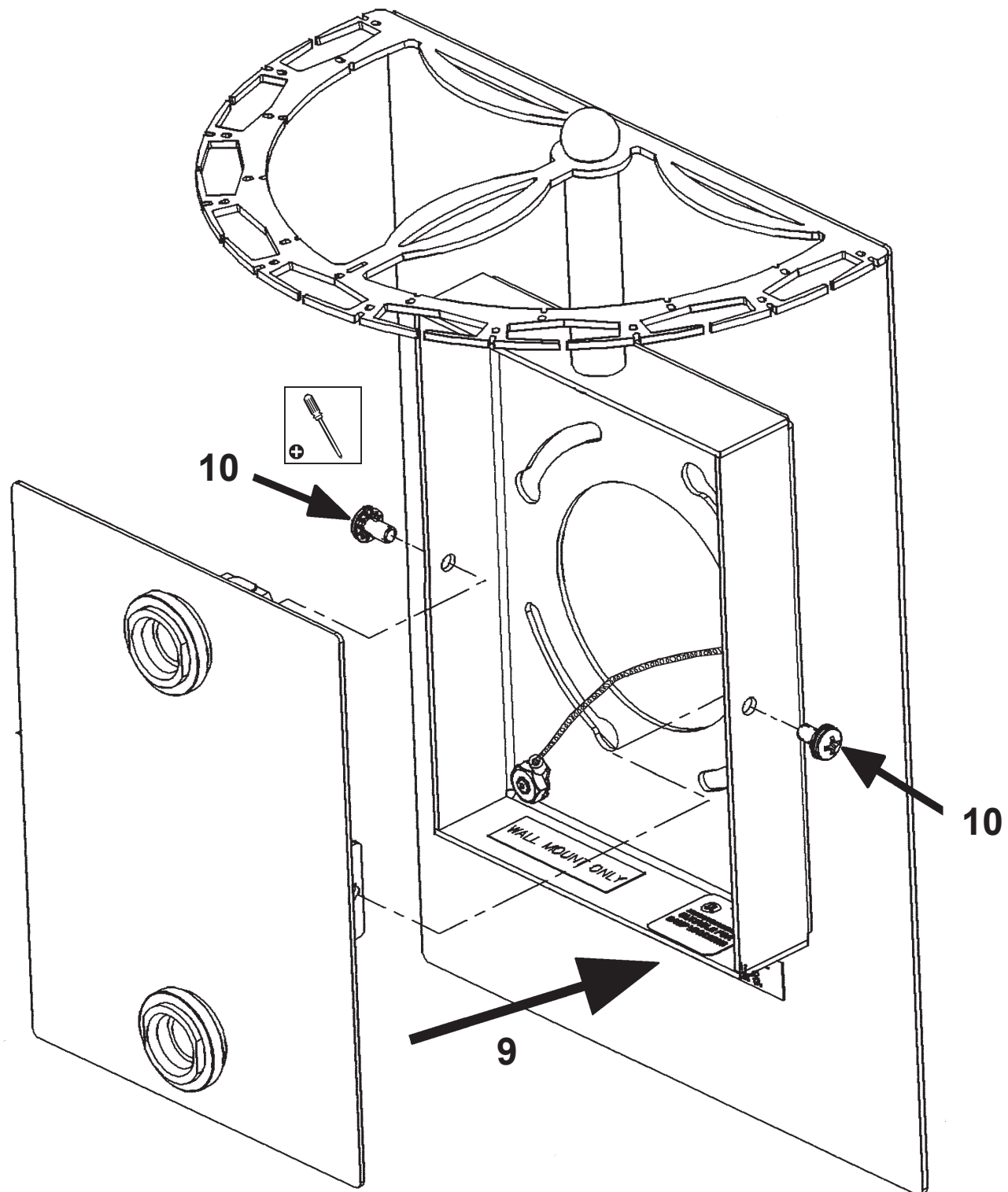

SARELLA RS8333N-__ __S

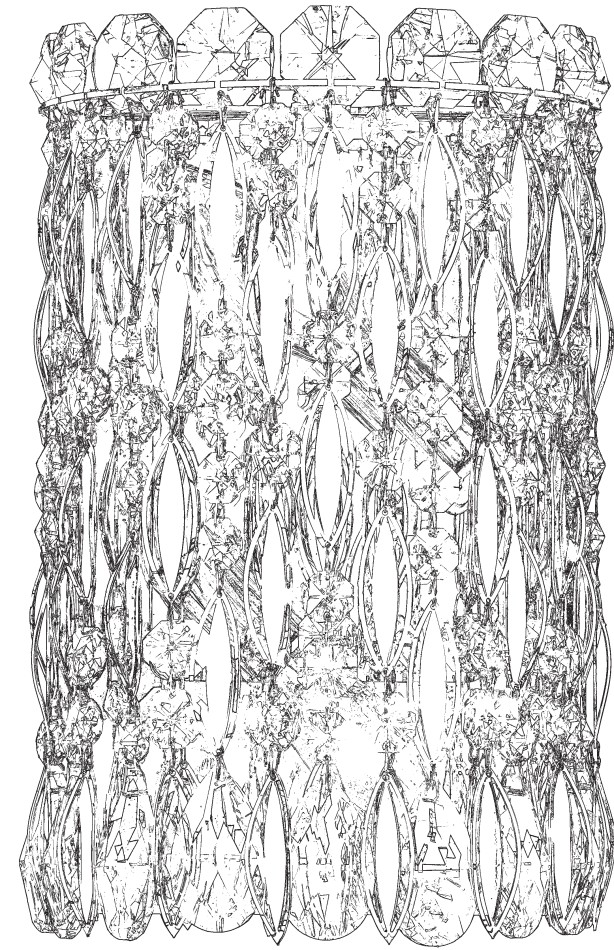











2 Lights
Length: 7"
Height: 11"
Extension: 4-1/2"
Hanging Weight: 4lbs.

THIS DESIGN IS THE PROPRIETARY
TRADE DRESS/TRADEMARK OF
W SCHONBEK LLC.

 **SCHONBEK** | 1870

 **SCHONBEK** | 1870

| | | | | | | | | |
|---------------------------------------------------------------------------------------|---------------------------------------------------------------------------------------|---------------------------------------------------------------------------------------|---------------------------------------------------------------------------------------|---------------------------------------------------------------------------------------|---------------------------------------------------------------------------------------|---------------------------------------------------------------------------------------|---------------------------------------------------------------------------------------|---------------------------------------------------------------------------------------|
|  |  |  |  |  |  |  |  |  |
| MAX <u>40</u> W | 110-120 V |  | | | | | | |

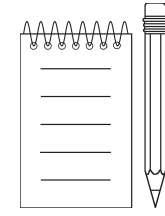
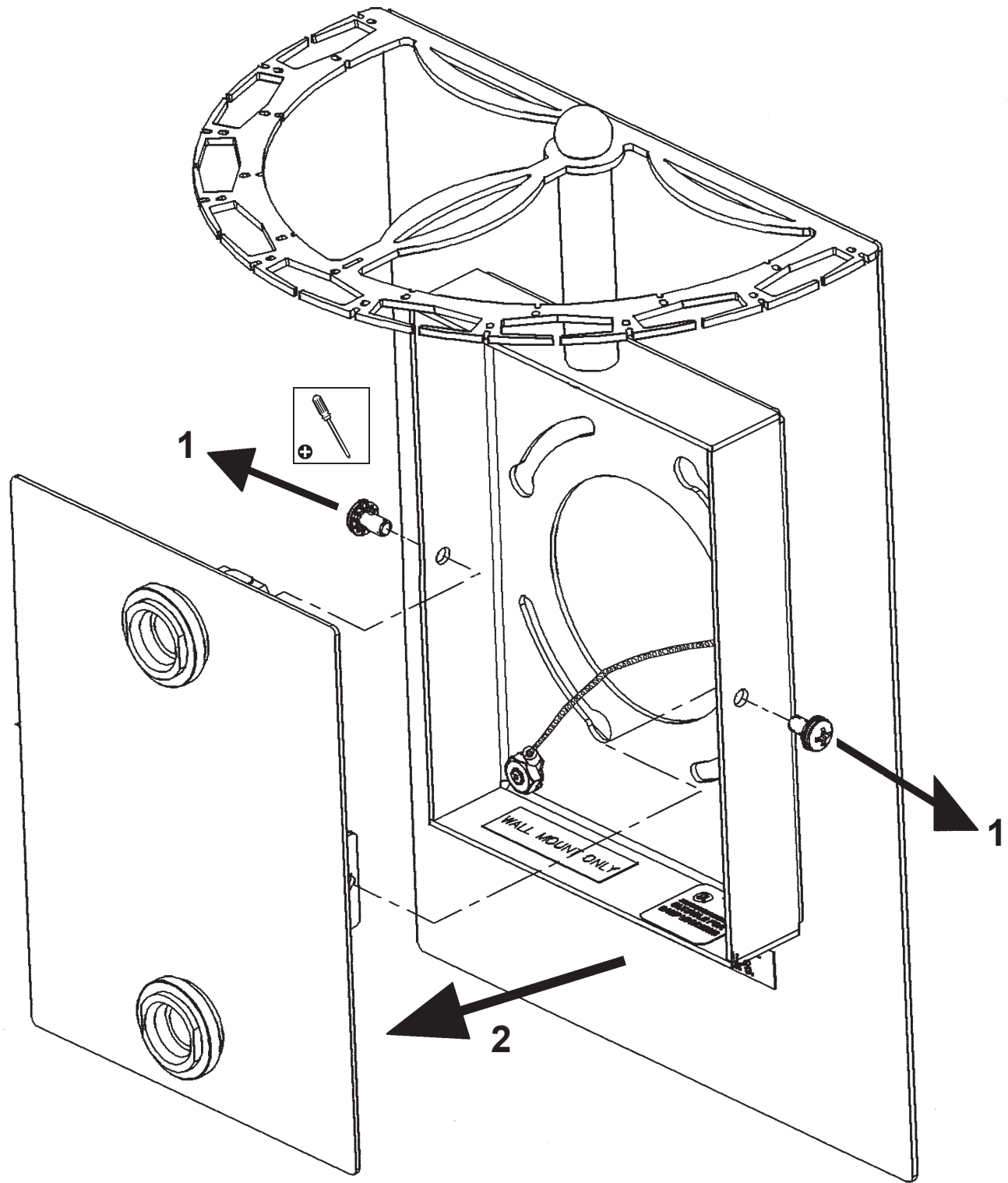

12

TRIM PLATE - TOP VIEW

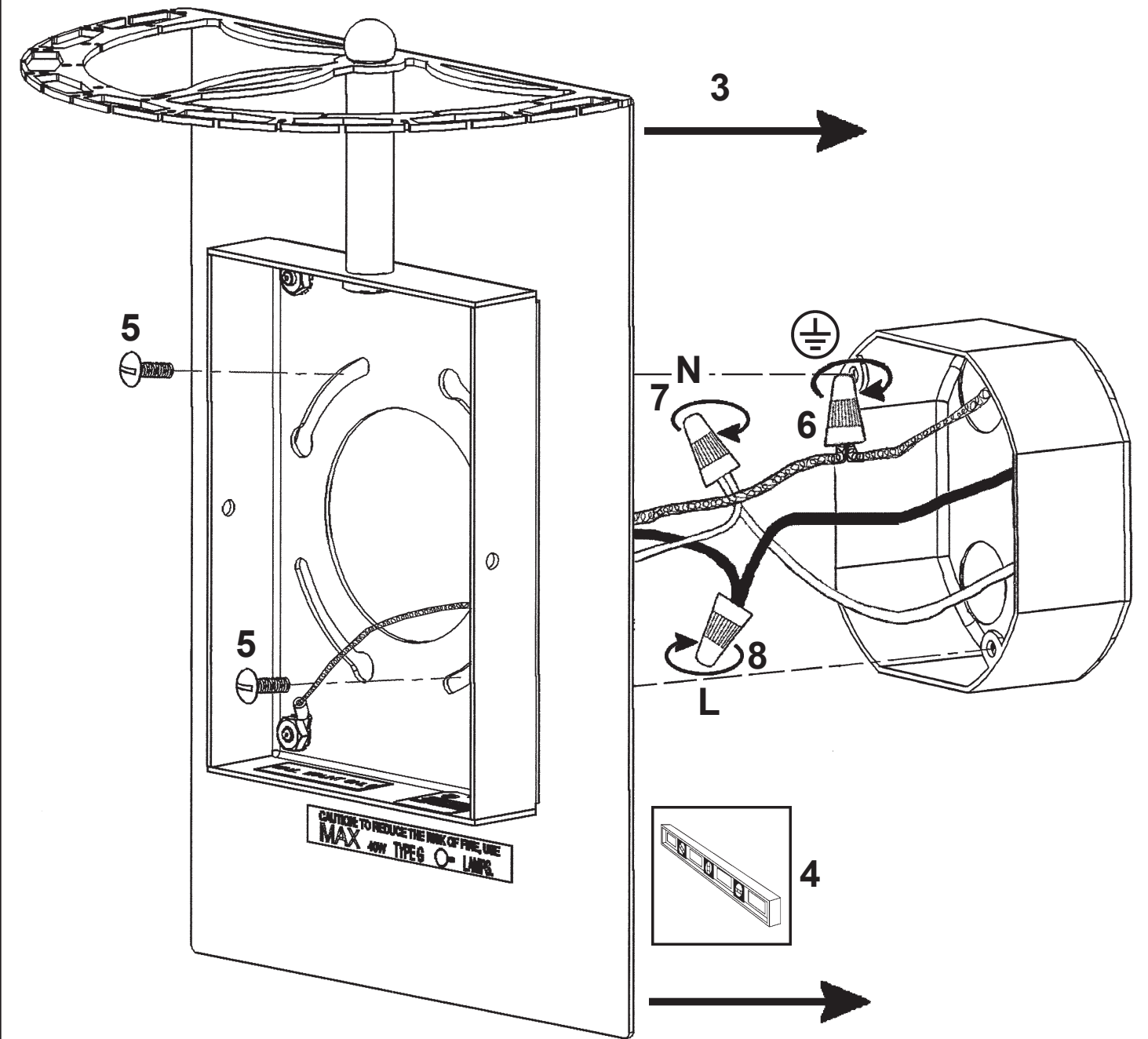
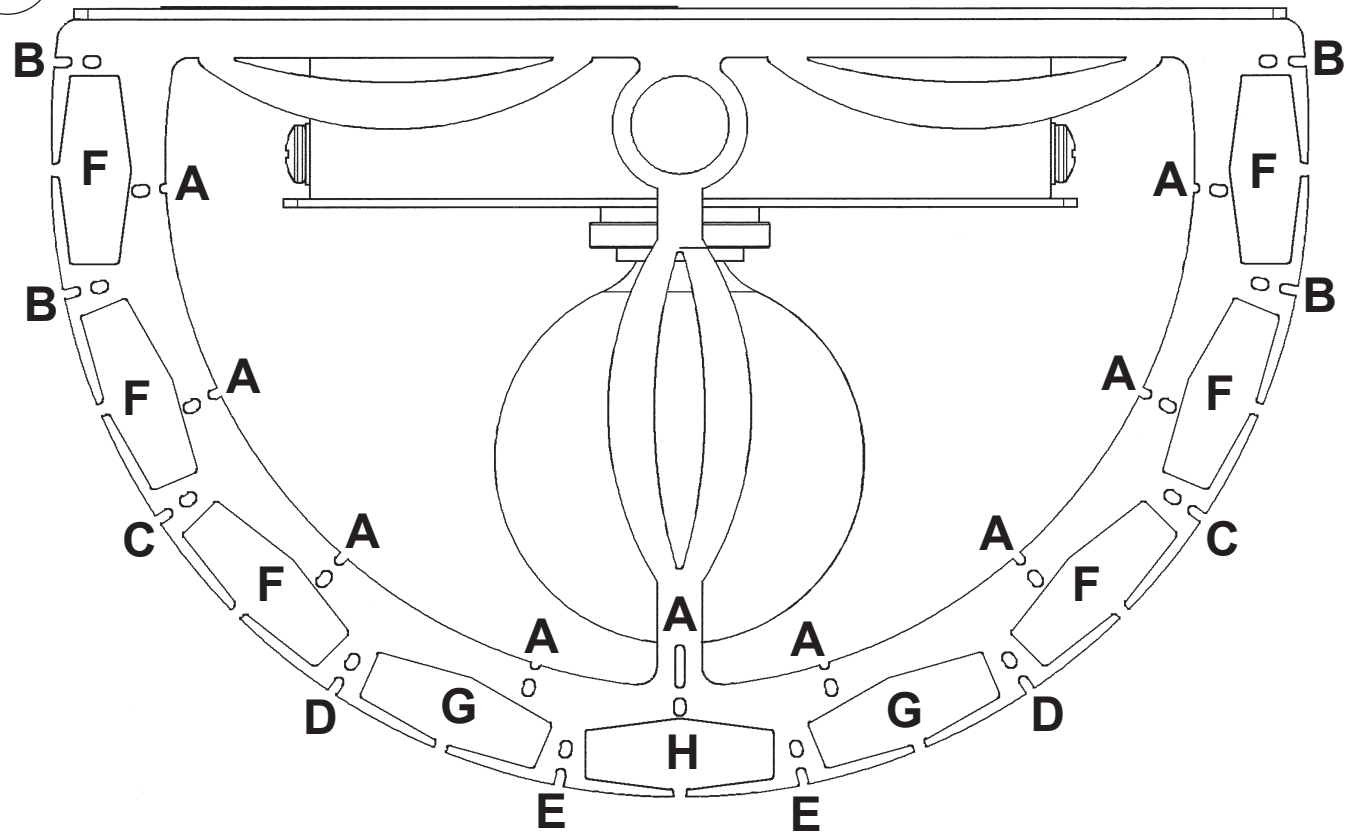

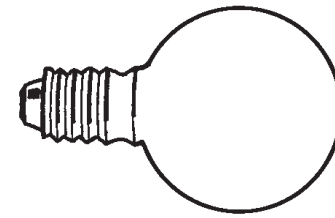

You will need 2 - G16-1/2
25 Watts Recommended
40 Watts Max

Install bulbs and be sure
to test fixture **BEFORE**
trimming.

