

CHANDELIER 1301 TRIM DIAGRAM

Instructions for electrician STEPS 2 - 10

WARNING:

2

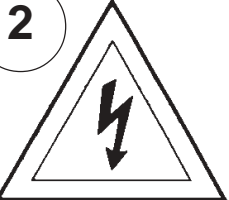

Electrical Danger

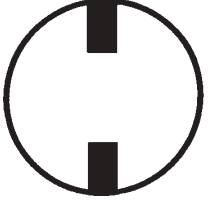

Turn Power Off

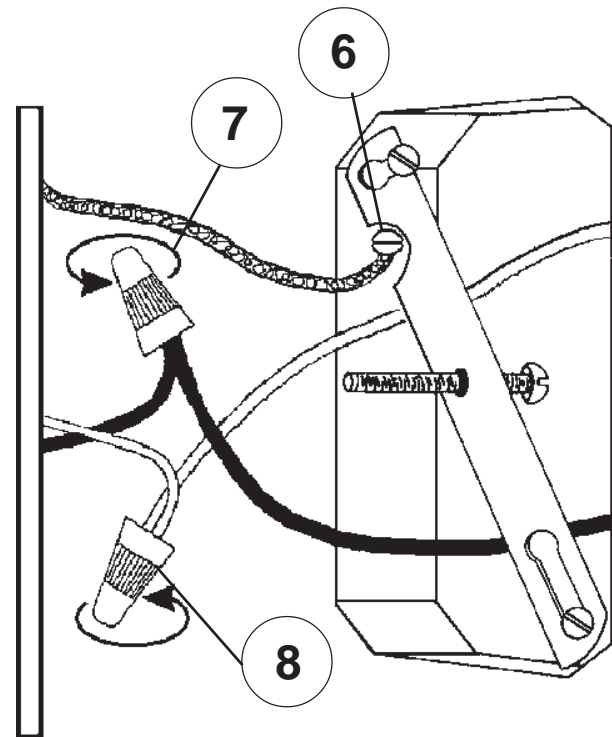
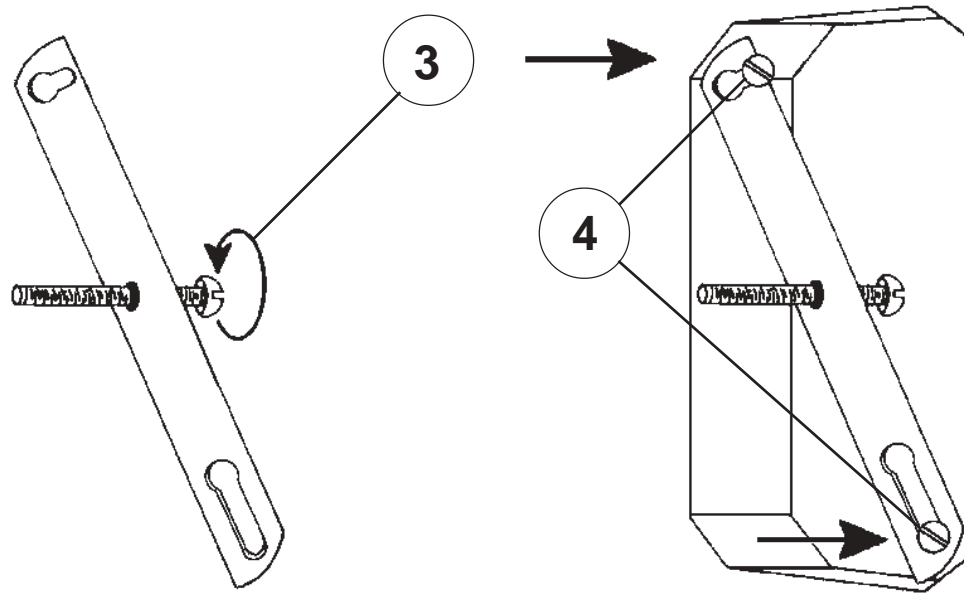

All electrical components must be installed by a licensed electrician in accordance with the National Electric Code and the appropriate local electrical codes.

5

Turn arms to line up holes in arms with dimple in plate. Tighten lock washer and nut to secure arms in place.

HOLE

DIMPLE

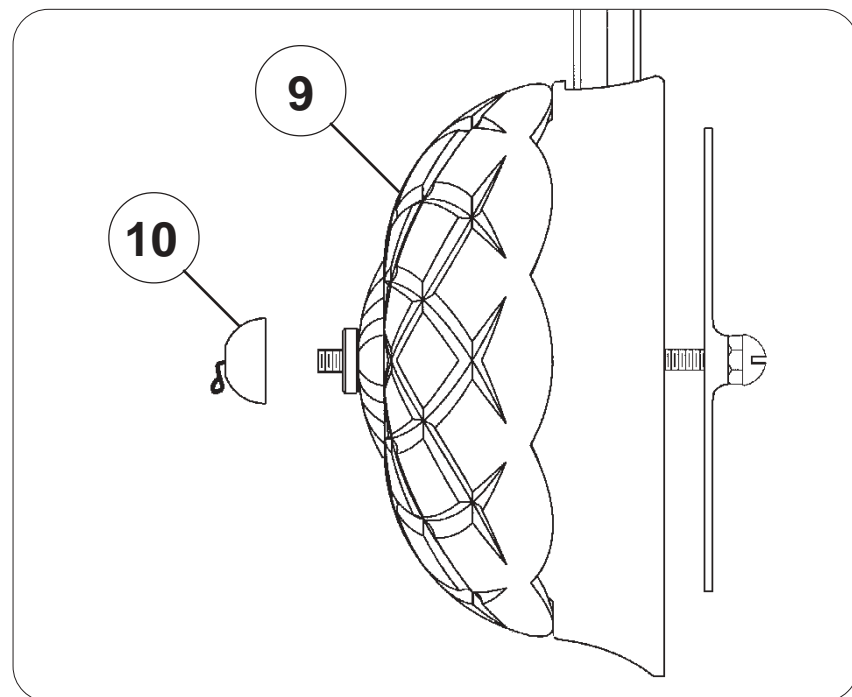

2 Lights
Diameter: 14-1/2"
Body Length: 16"
Extension: 6"
Hanging Weight: 5 pounds

THIS DESIGN IS THE PROPRIETARY TRADE DRESS/TRADemark OF SCHONBEK WORLDWIDE LIGHTING INC.

SCHONBEK®

See diagram on back page
Follow steps in exact order
Save this trim diagram for future reference

1 **IMPORTANT**
Person who opens carton should record the following information for future service.

CODE # _____ Four-digit number on outside of carton.
PACKER # _____ See crystal package label.
ORDER # _____ See crystal package label.

SCHONBEK IS A WORLD LEADER IN CHANDELIER DESIGN. PATENTS INCLUDE:
#D5,460,269



Instructions for crystal trimming
STEPS 11 - 17

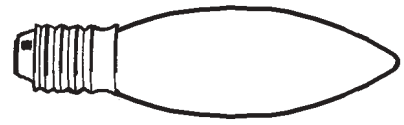

11

You will need 2 - C10
 25 Watts Recommended
 60 Watts Max

**Install bulbs and be
 sure to test fixture
 BEFORE trimming.**

VIEW "A"

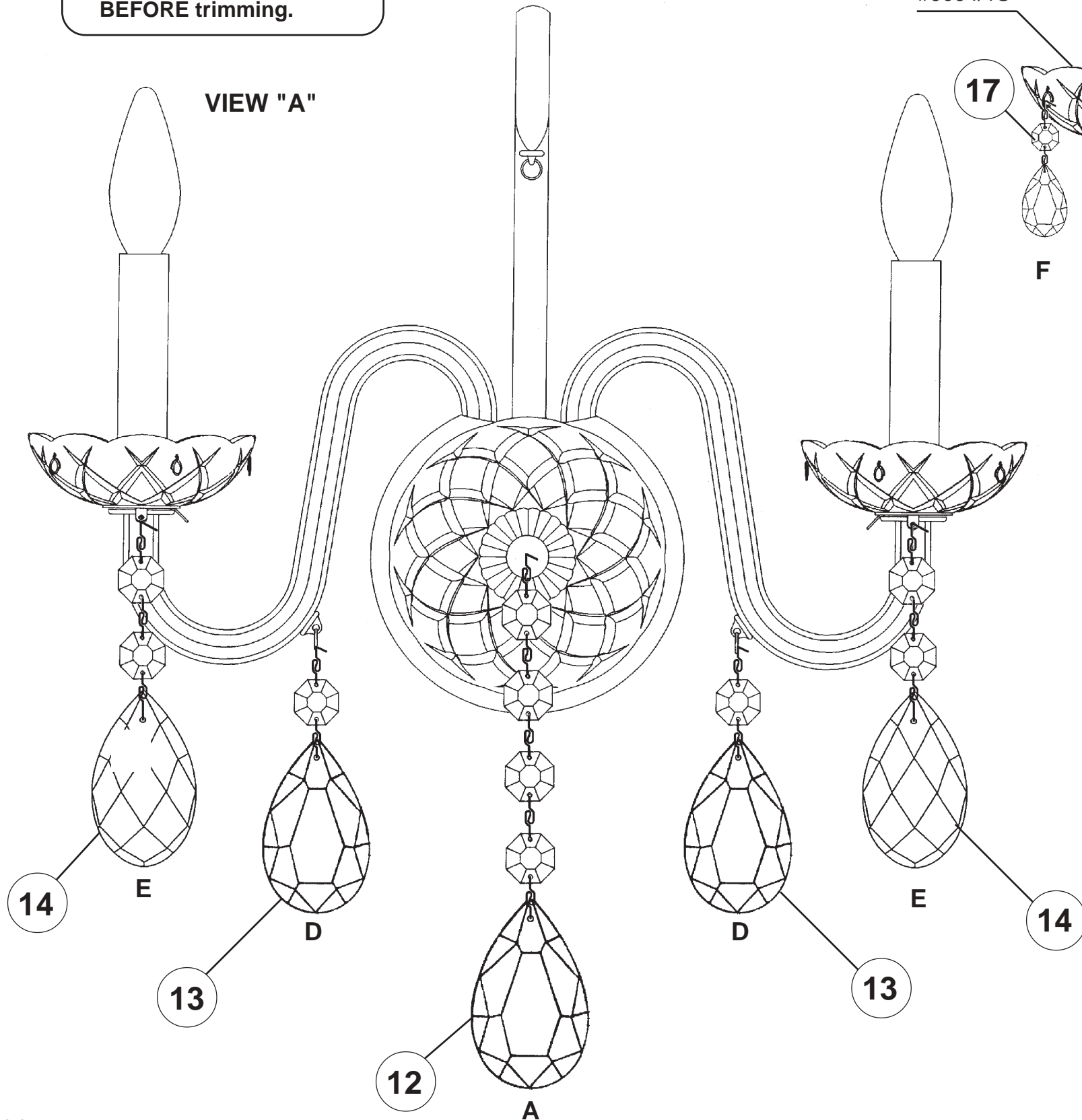

VIEW "B"

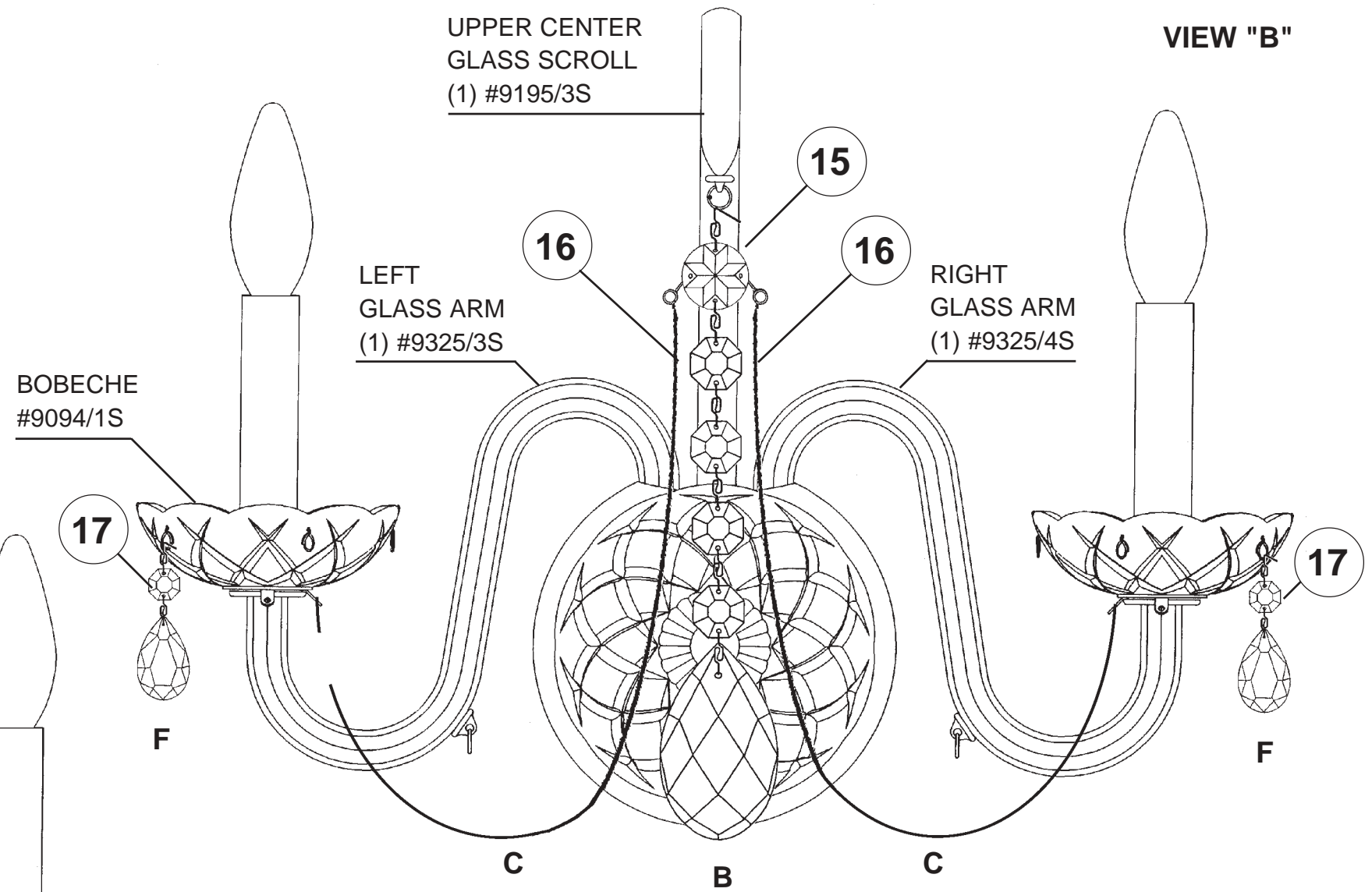

UPPER CENTER
 GLASS SCROLL
 (1) #9195/3S

LEFT
 GLASS ARM
 (1) #9325/3S

RIGHT
 GLASS ARM
 (1) #9325/4S

BOBECHE
 #9094/1S

CAUTION: Glass parts are fragile.
 To avoid breakage use care when
 assembling or cleaning.

**WHEN ORDERING REPLACEMENT
 ARM(S):**

- 1 Give arm number from trim diagram
- 1 Give color code from the arm itself

