

PETIT CRYSTAL DELUXE 5893- __ __A

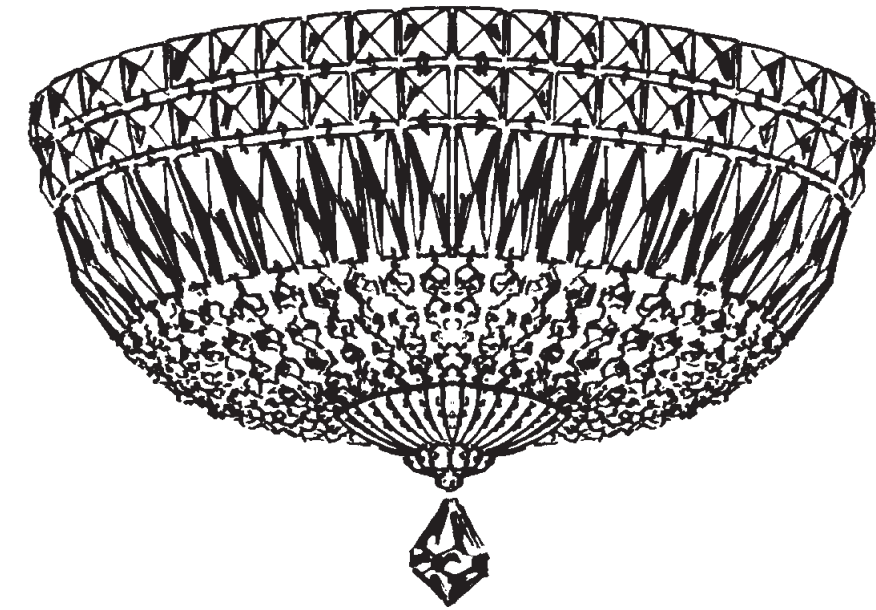

5 Lights
Diameter: 14"
Body Length: 8"
Hanging Weight: 7 lbs.

THIS DESIGN IS THE PROPRIETARY
TRADE DRESS/TRADEMARK OF
SWAROVSKI LIGHTING, LTD.



SCHONBEK®



SCHONBEK®

MAX 40 W		110-120 V						

SCHONBEK® is a member of the Swarovski group.

All electrical components must be installed by a licensed electrician in accordance with the National Electric Code and the appropriate local electrical codes.

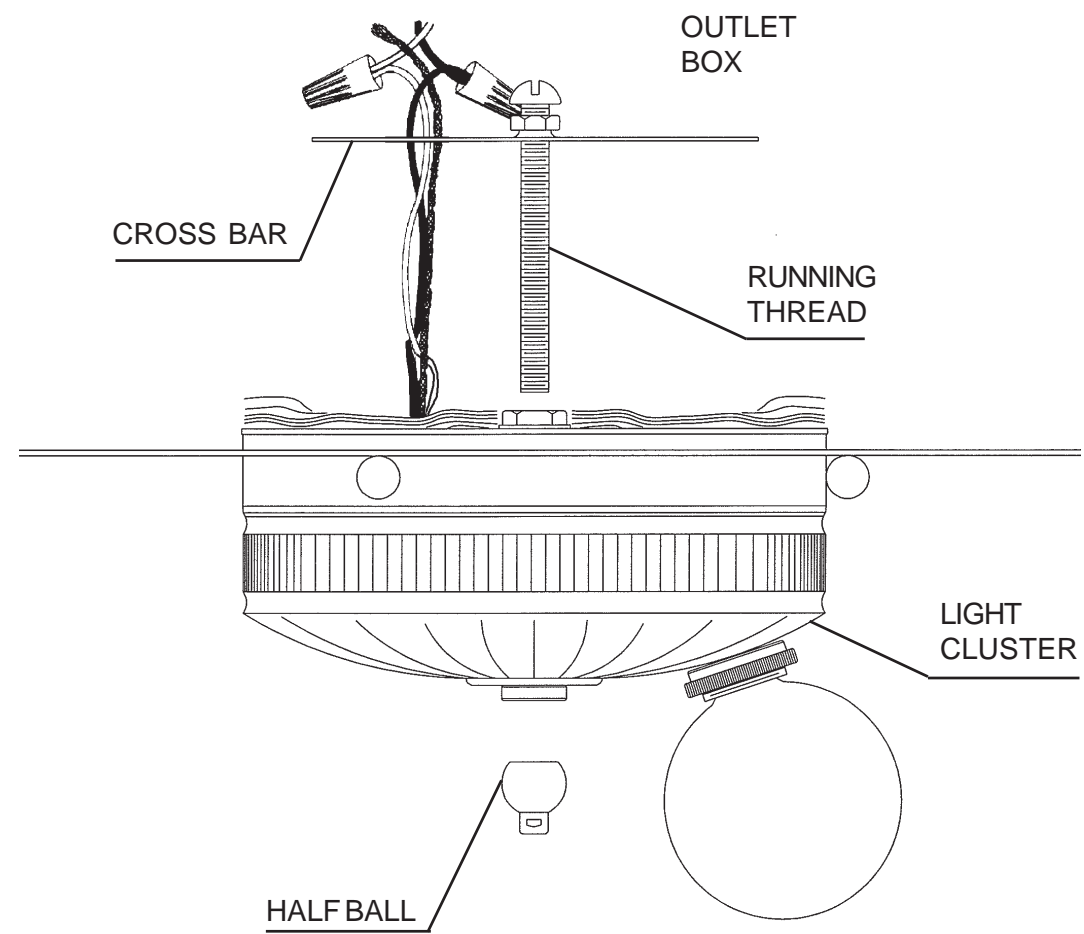

- 1** Remove crossbar from light cluster and attach to outlet box.
- 2** Feed stem wires through crossbar and attach to power wires in outlet box.
- 3** Place light cluster over thread attached to crossbar and secure with half ball.

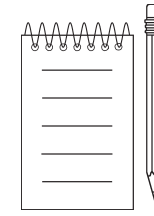



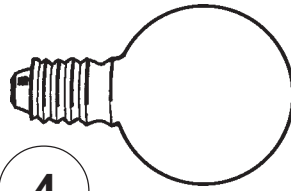

4

You will need 5 - G16-1/2
25 Watts Recommended
40 Watts Max
MIN 90°C SUPPLY
CONDUCTORS

Install bulbs and be sure
to test fixture BEFORE
trimming.

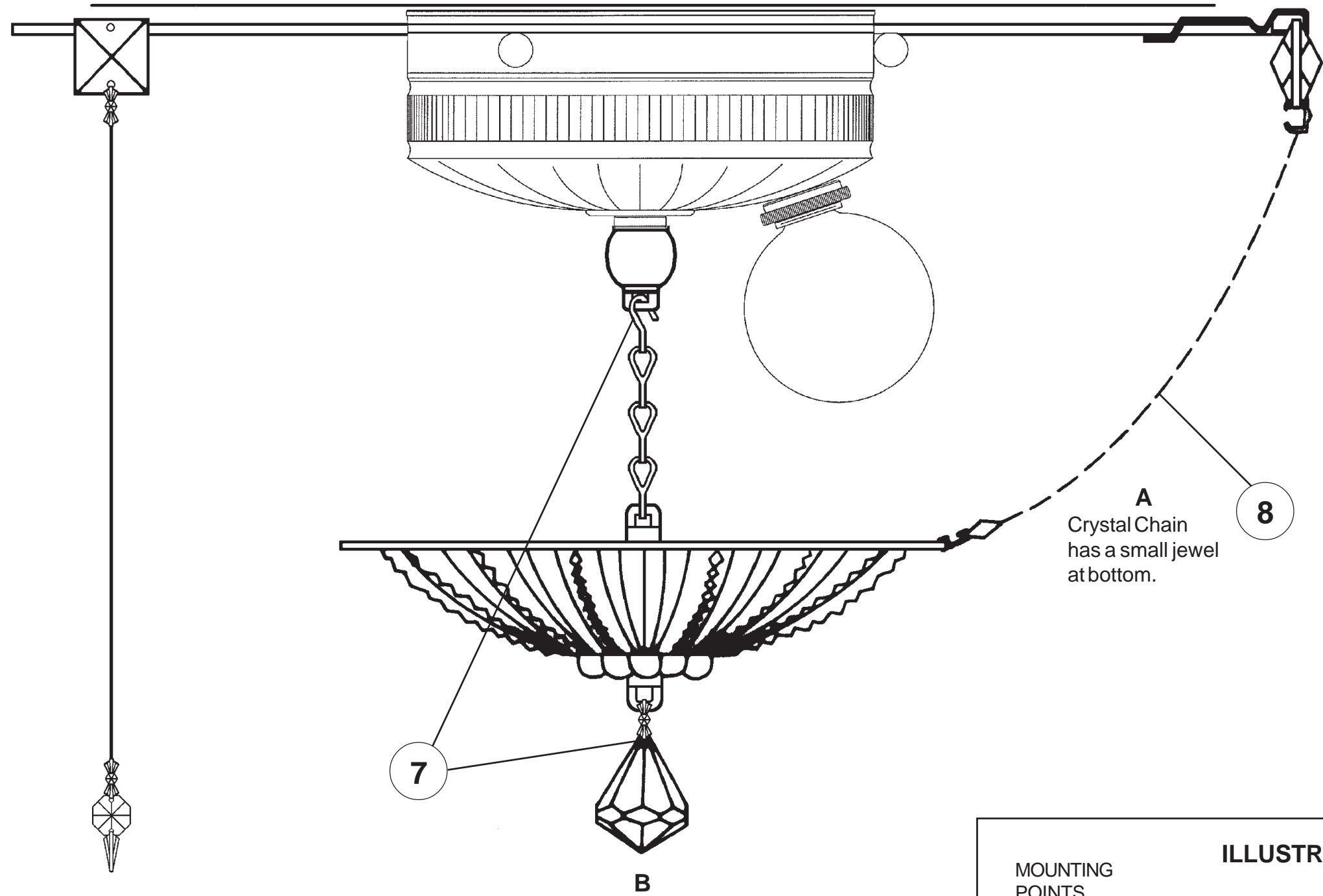

A
Crystal Chain
has a small jewel
at bottom.

8

7

B

ILLUSTRATION 4

MOUNTING
POINTS

LIGHT
CLUSTER

MIRROR
PLATE

6 Align holes in mirror plate with the balls on
the light cluster, raise mirror plate over balls,
then turn mirror clockwise until holes are halfway
between balls. See illustration #4.

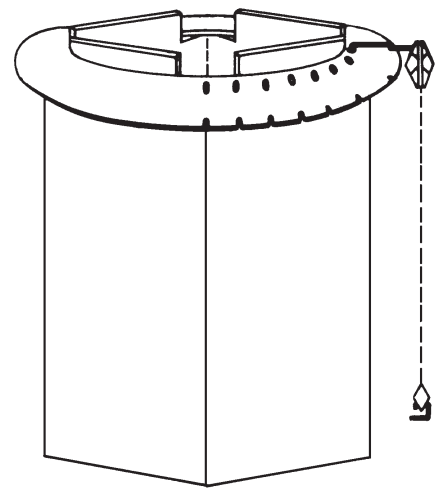

5 Set mirror plate on cardboard stand. Hook
all Crystal Chains "A" into slots in the mirror
plate so the metal accessories face outwards
and the square jewel is on the upper end. See
illustrations #1 - #3. NOTE: Allow ends with
small jewels to hang loose.

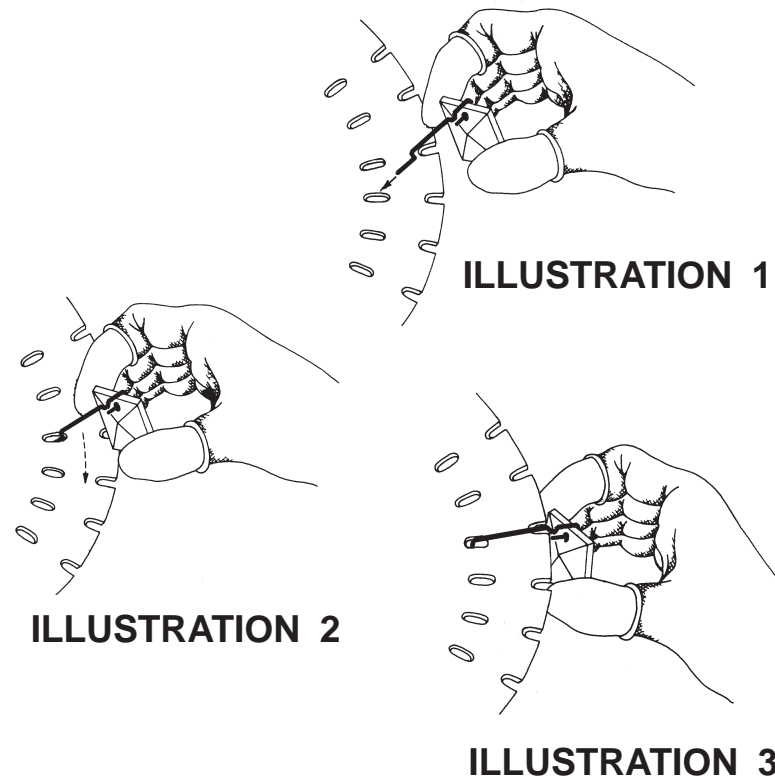

ILLUSTRATION 1

ILLUSTRATION 2

ILLUSTRATION 3