



**SCHONBEK®**

**RENAISSANCE 3787- \_\_\_\_\_**



**T**HIS DESIGN IS THE PROPRIETARY  
TRADE DRESS/TRADEMARK OF  
SWAROVSKILIGHTING, LTD.

8 Lights  
Diameter: 26-1/2"  
Body Length: 35"  
Hanging Weight: 37 lbs.



**SCHONBEK®**

MAX <b>60</b> W		110-120 V					

SCHONBEK® is a member of the Swarovski group.

All electrical components must be installed by a licensed electrician in accordance with the National Electric Code and the appropriate local electrical codes.

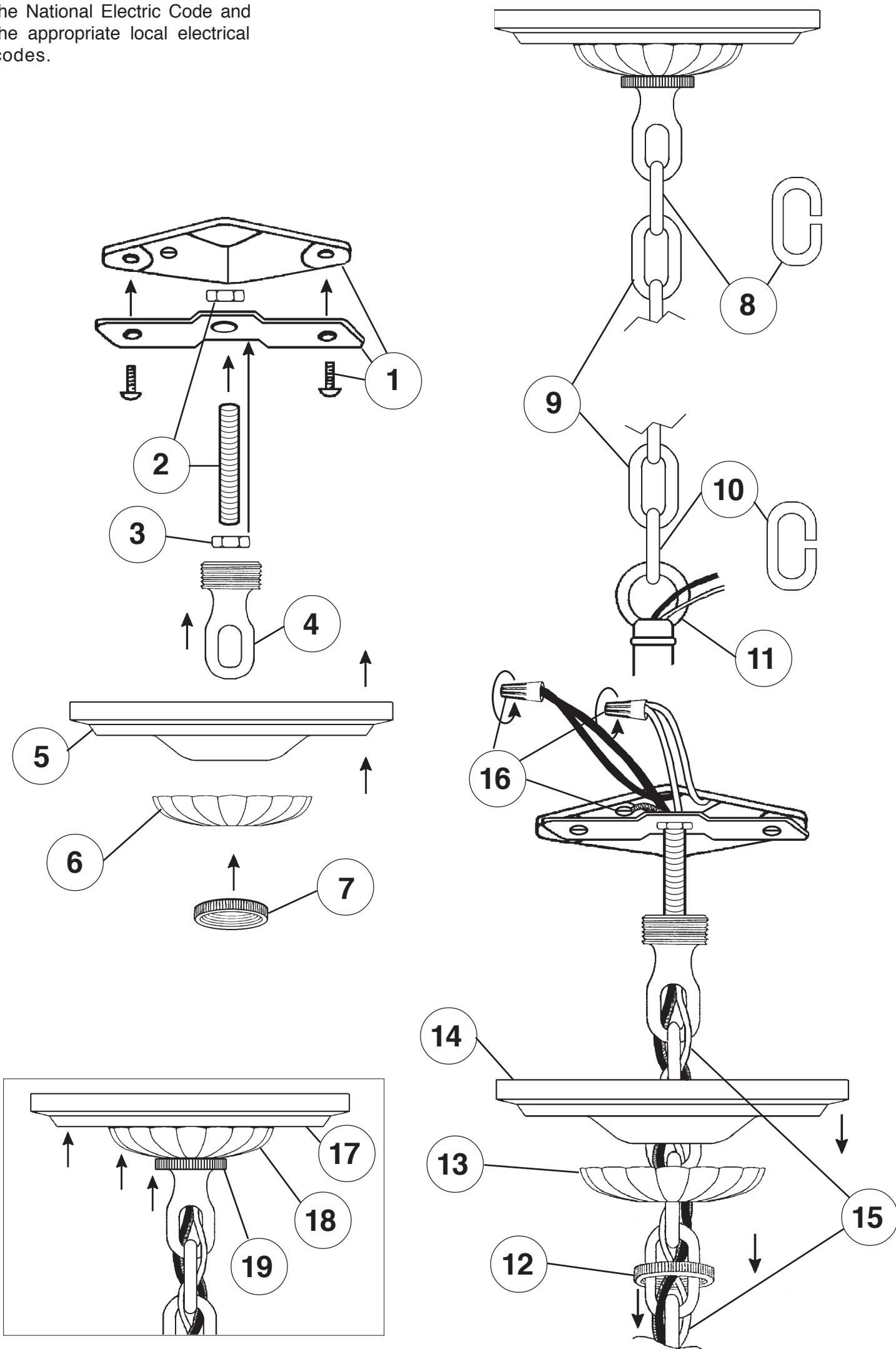

**Crystal Set #3 in Black**

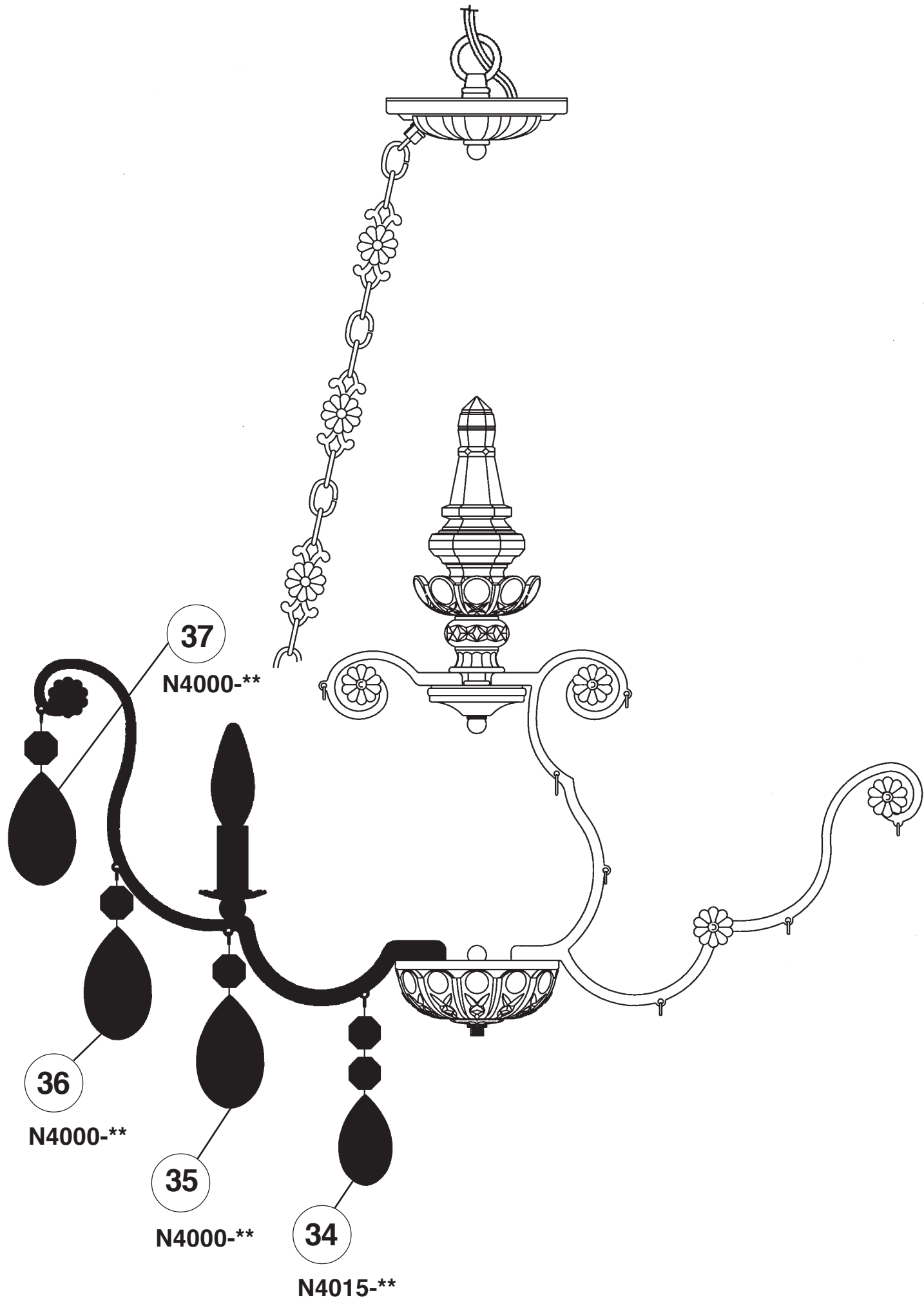

**SET #1**

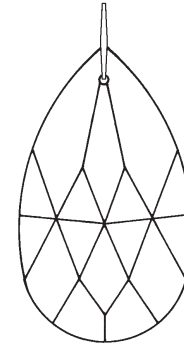

**N4014-\*\***  
2-1/2"  
63mm

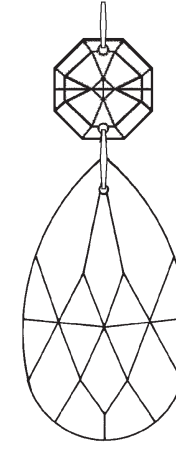

**N4003-\*\***  
2-1/2"  
63mm

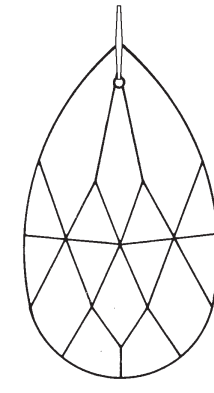

**N4004-\*\***  
3"  
76mm

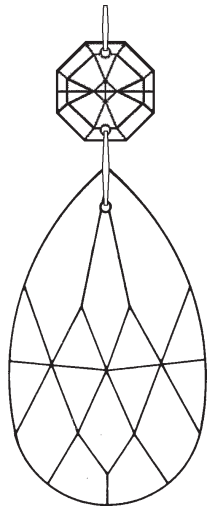

**N4000-\*\***  
3"  
76mm

**SET #2**

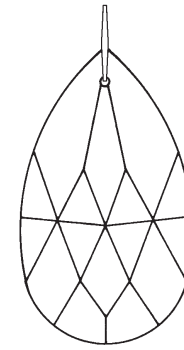

**N4014-\*\***  
2-1/2"  
63mm

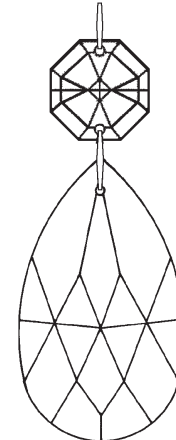

**N4003-\*\***  
2-1/2"  
63mm

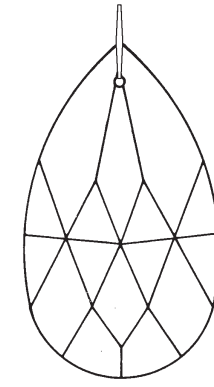

**N4004-\*\***  
3"  
76mm

**SET #3**

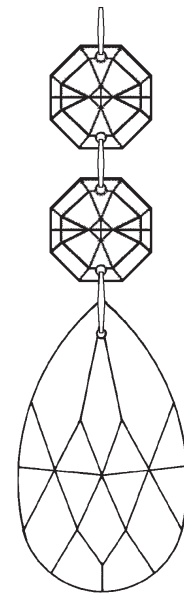

**N4015-\*\***  
2-1/2"  
63mm

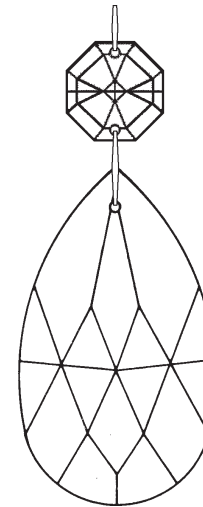

**N4000-\*\***  
3"  
76mm

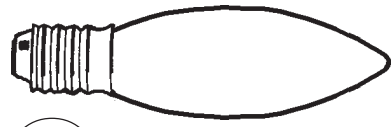

20

You will need 8 - B10  
25 Watts Recommended  
60 Watts Max

Install bulb and be sure  
to test fixture BEFORE  
trimming.

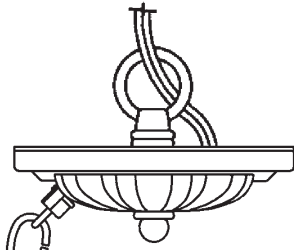

Crystal Set #1 in Black



21

9552/150

24

N4000-\*\*

23

N4014-\*\*

22

N4014-\*\*

29

N4004-\*\*

28

N4004-\*\*

27

N4003-\*\*

25

N439\*\*-\*\*

Crystal Set #2 in Black

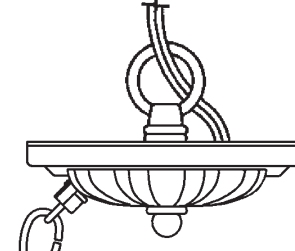

9302

9419

30

N4014-\*\*

33

N4004-\*\*

32

N4004-\*\*

31

N4003-\*\*

9319

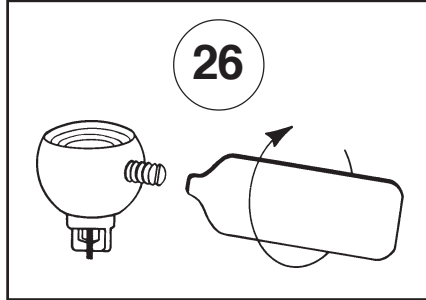

26

