

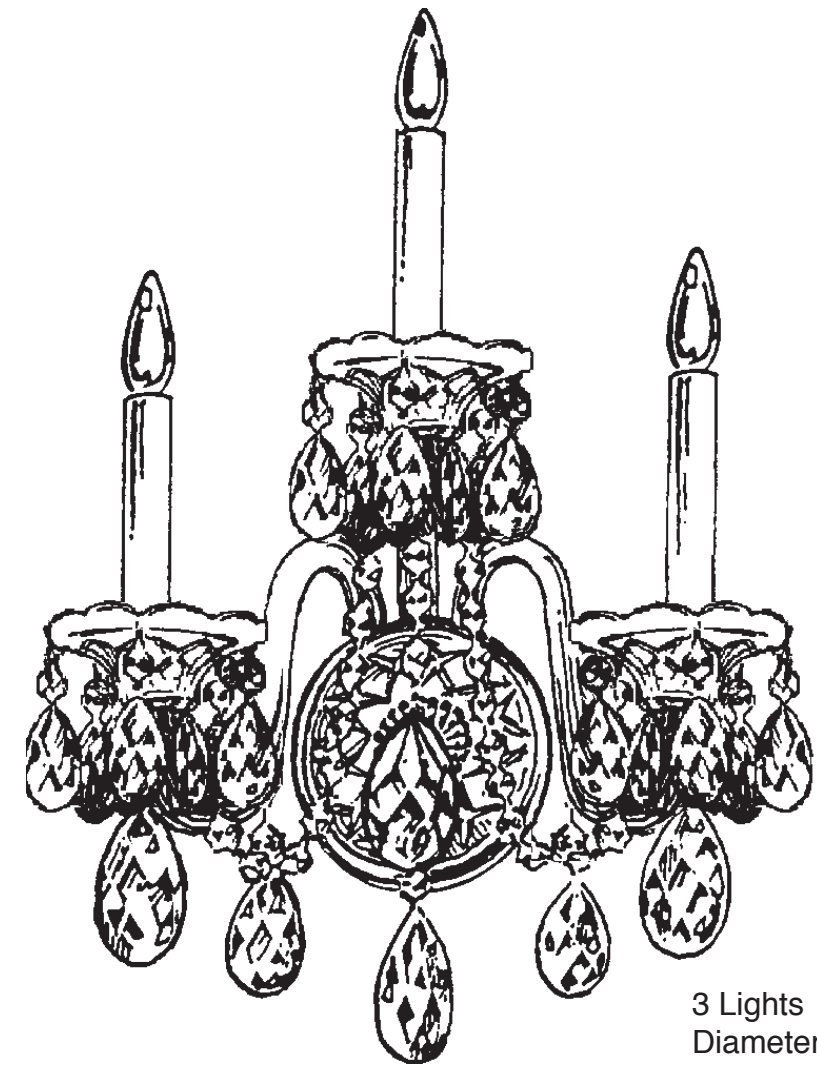

SCHONBEK®

STERLING 2992- __ __ S



3 Lights
Diameter: 15-1/2"
Body Length: 21"
Extension: 7-1/2"
Hanging Weight: 5 lbs.

THIS DESIGN IS THE PROPRIETARY
TRADE DRESS/TRADEMARK OF
SWAROVSKILIGHTING, LTD.



SCHONBEK®

MAX 60 W		110-120 V						

SCHONBEK® is a member of the Swarovski group.

All electrical components must be installed by a licensed electrician in accordance with the National Electric Code and the appropriate local electrical codes.

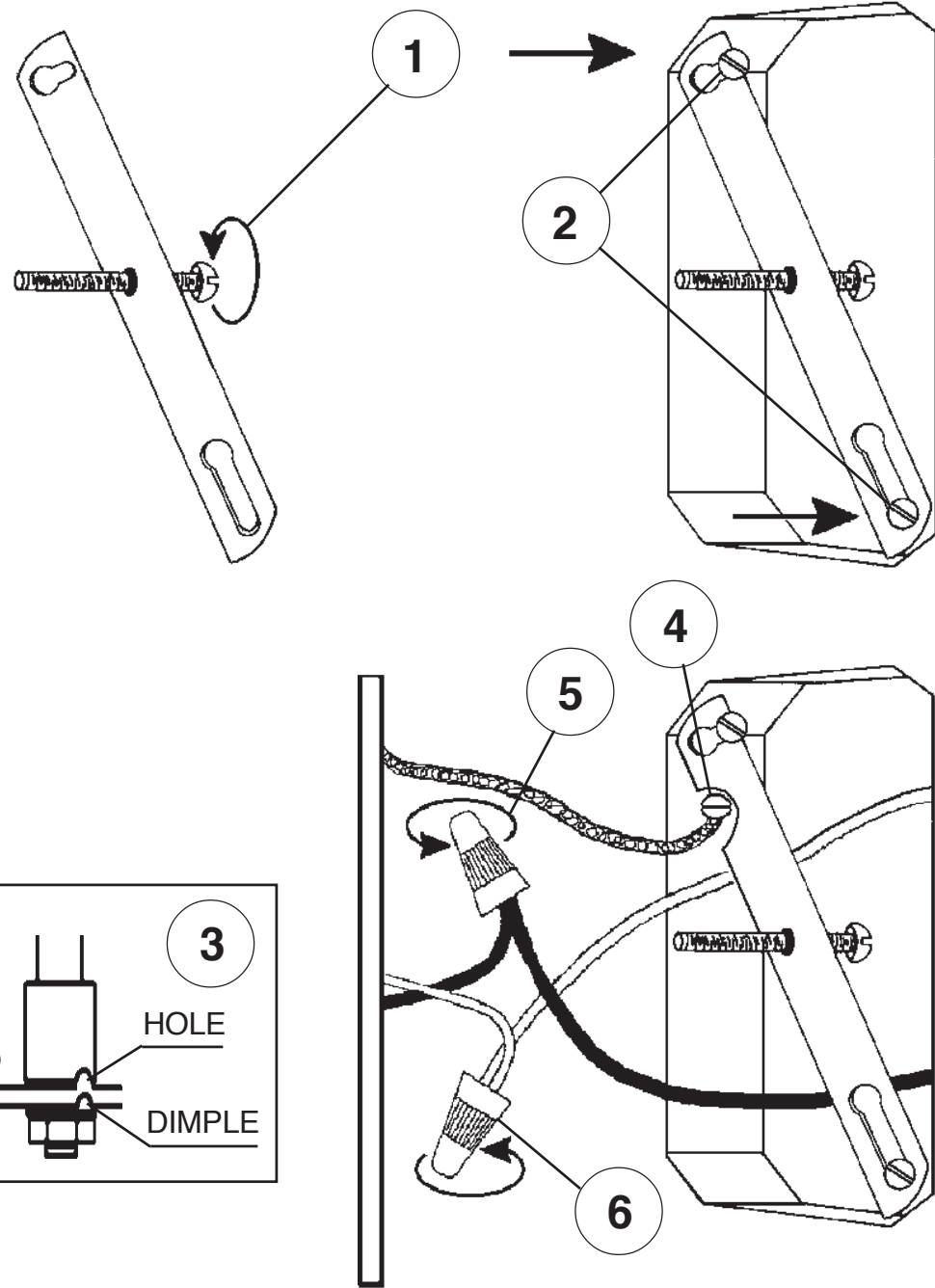

Turn arms to line up holes in arms with dimple in plate. Tighten lock washer and nut to secure arms in place.

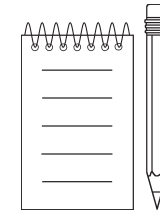
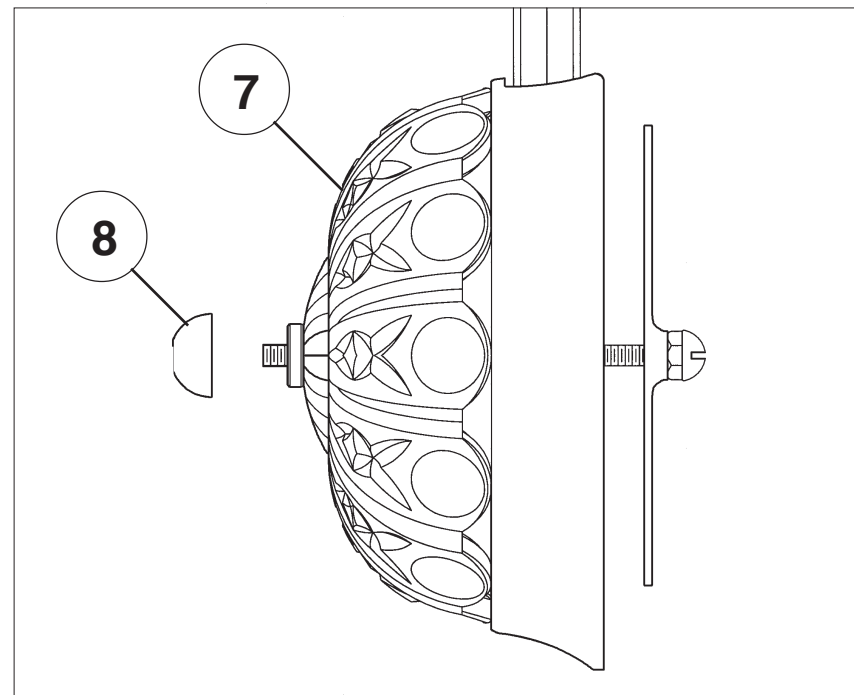
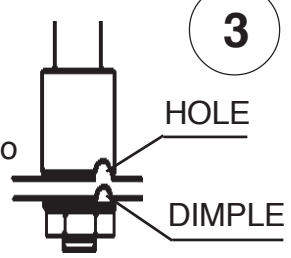





9

You will need 3 - B10
25 Watts Recommended
60 Watts Max

Install bulbs and be sure
to test fixture **BEFORE**
trimming.

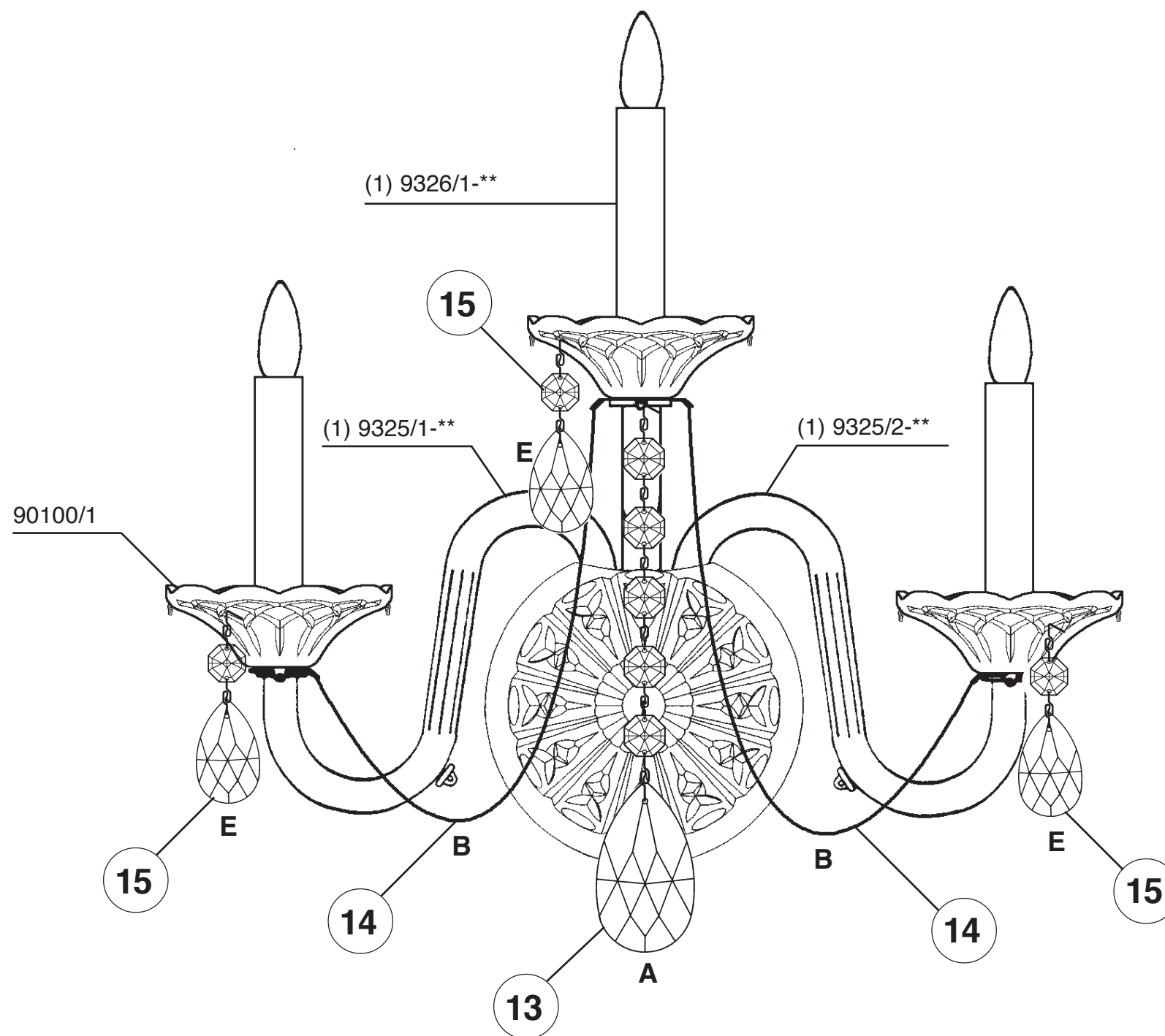
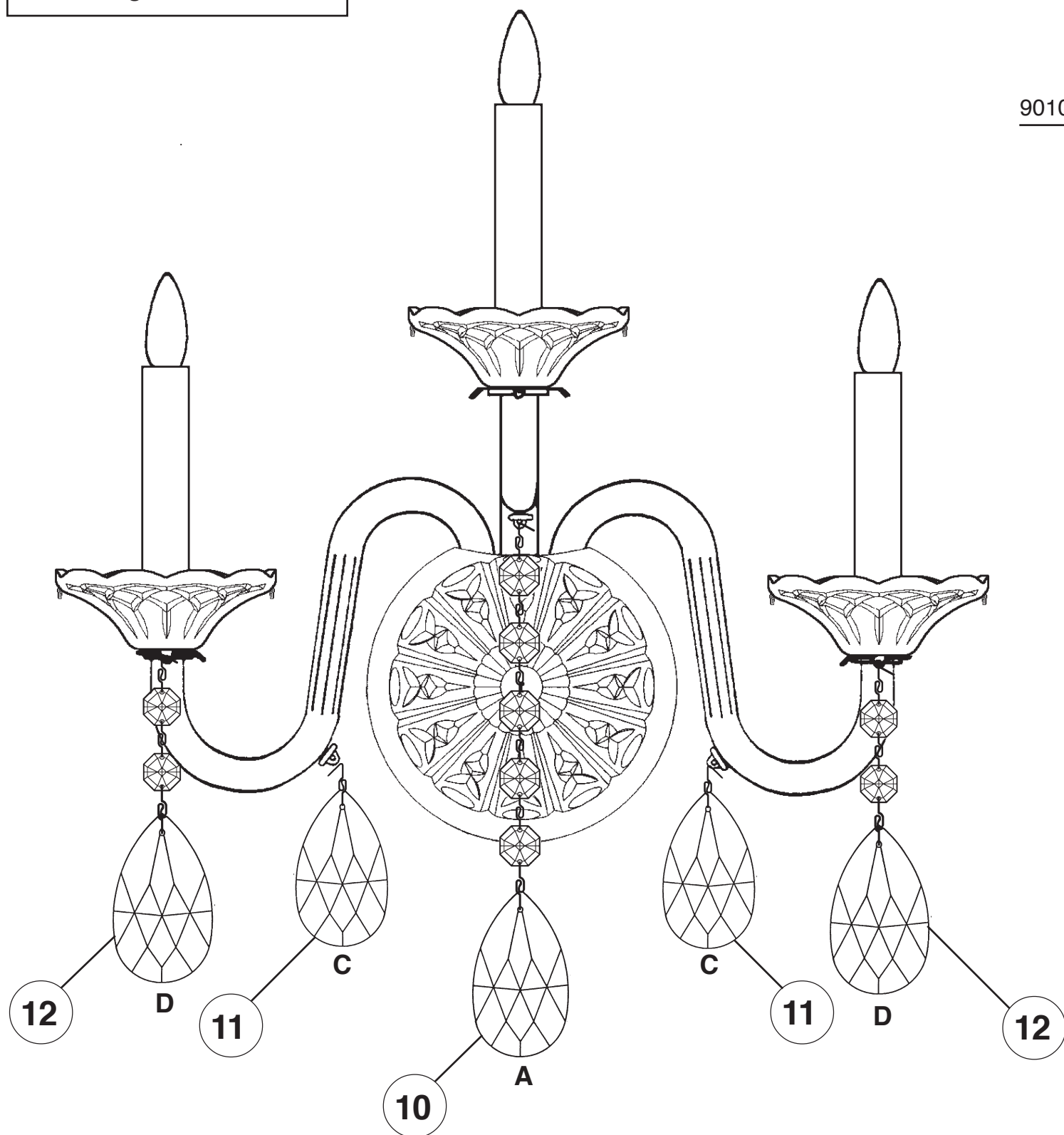

(1) 9326/1-**

15

(1) 9325/1-**

E

(1) 9325/2-**

90100/1

15

E

14

B

13

A

B

14

E

15

CAUTION:
Glass parts are fragile. To
Avoid breakage use care when
assembling or cleaning.

